

Stair Rail Direct.com



Edition 10
Wood stair parts catalog.

Balusters

Below are examples of the newel top options that are available for the items in our Traditional line of Wood Stair Parts.

All traditional balusters can be fluted, twisted, or reeded upon request.

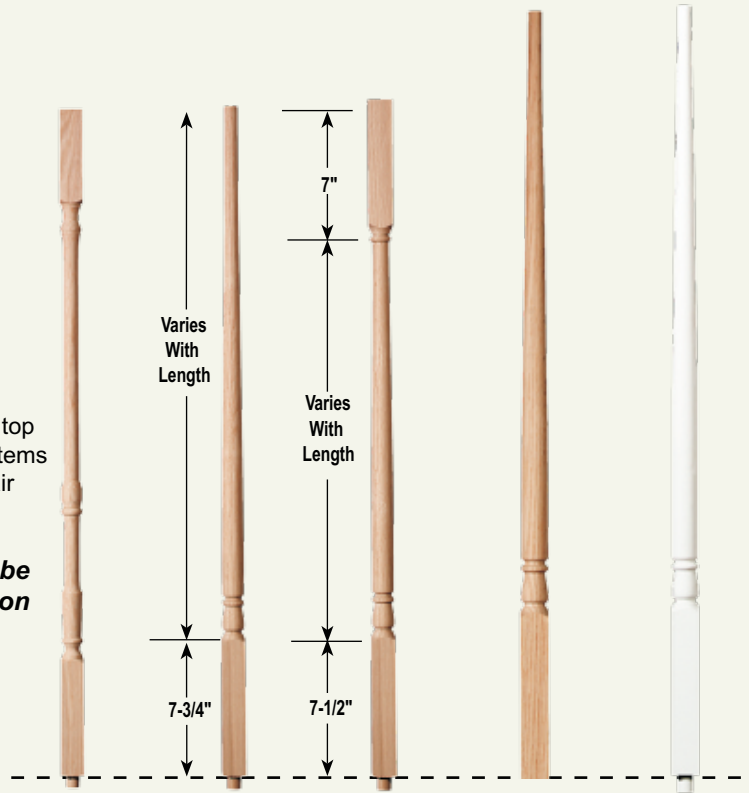
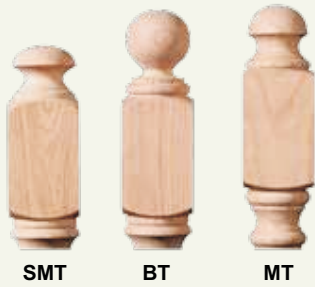

5067 1-1/4" x 31" 1-1/4" x 34" 1-1/4" x 36" 1-1/4" x 39" 1-1/4" x 41"	5015 1-1/4" x 31" 1-1/4" x 34" 1-1/4" x 36" 1-1/4" x 39" 1-1/4" x 41"	5014 1-1/4" x 31" 1-1/4" x 34" 1-1/4" x 36" 1-1/4" x 39" 1-1/4" x 41"	5015 LB 41" No Dowel	5015 Primed Available in domestic or imported
---	---	---	-----------------------------------	---



Traditional

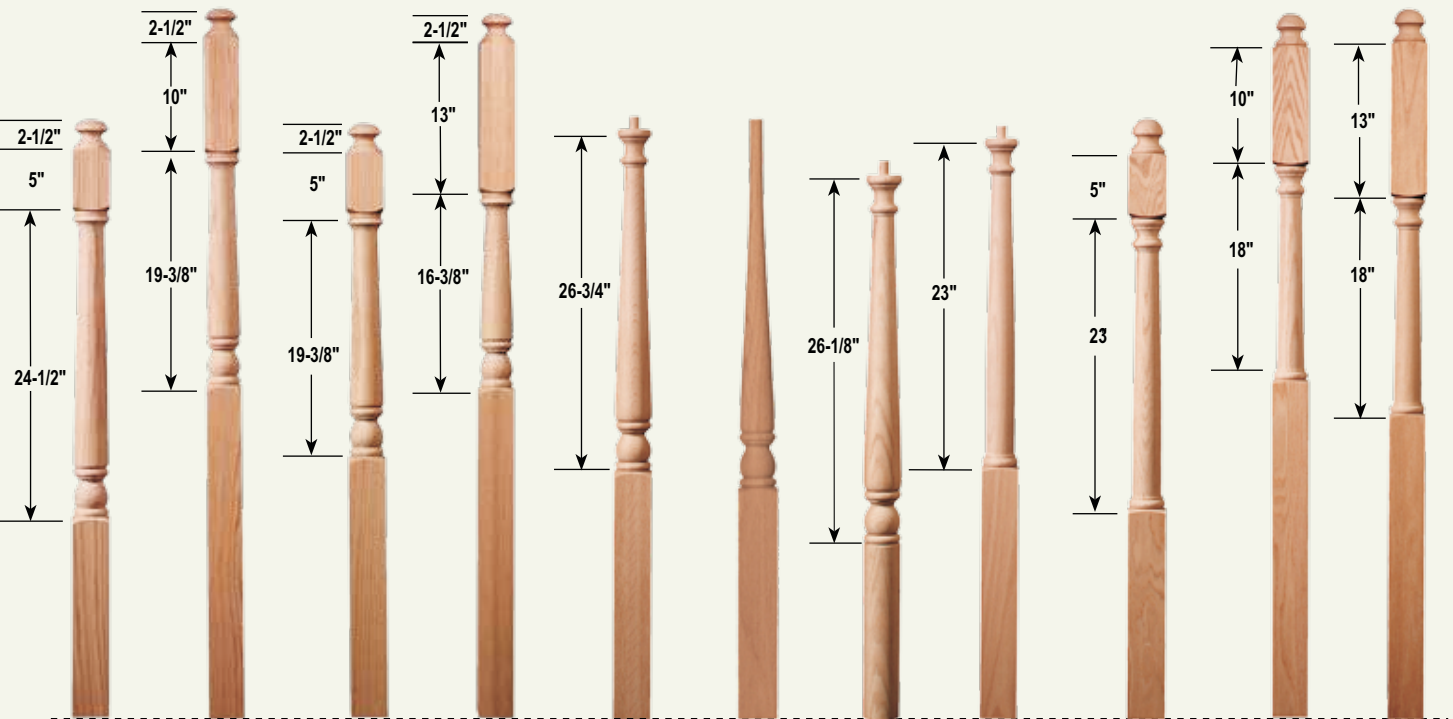

1640 3" x 48" 3" x 54" 3" x 60" 3" x 72"	1641 3" x 48" 3" x 60" 3" x 72"	1642 3" x 48" 3" x 60"	1643 3" x 60" 3" x 72"	1600 3" x 48" 3" x 54" 3" x 60" 3" x 72"	1605 3" x 48" 3" x 60"	1606 Round Base	4010 3" x 48" 3" x 60"	4040 3" x 48"	4045 3" x 48" 3" x 60" 3" x 72"	4046 3" x 60" 3" x 72"
1740 3-1/4" x 48" 3-1/4" x 60"	1741 3-1/4" x 48" 3-1/4" x 60"	1742 3-1/4" x 48" 3-1/4" x 60"	1743 3-1/4" x 60"	1700 3-1/4" x 48" 3-1/4" x 60"	1607 Square Base 3" x 38" 3" x 41" 3" x 44"	4042 3" x 54"	4043 3" x 60"			

Newels

Balusters

This Series Available in Octagon by Special Order.
 (Excluding # 5205P & #5200P)

Model	Top Section Height	Bottom Section Height	Notes
5205 P	6-3/4"	7-3/4"	Varies With Length
5200 P	-	7-3/4"	Varies With Length
5300 P	-	7-3/4"	Varies With Length
5105 P	5-3/4"	7-3/4"	Varies With Length
5105-SQ	6"	-	16-1/2"
5005 P	-	-	Varies
5300 LB	-	13-1/2"	(No Dowel) 41"

Model	1-1/4" x 31"	1-1/4" x 34"	1-1/4" x 36"	1-1/4" x 39"	1-1/4" x 41"
5205 P	✓	✓	✓	✓	✓
5200 P	✓	✓	✓	✓	✓
5300 P	✓	✓	✓	✓	✓
5105 P	✓	✓	✓	✓	✓
5105-SQ	✓	✓	✓	✓	✓
5005 P	✓	✓	✓	✓	✓
5300 LB	✓	✓	✓	✓	✓



Hampton



Model	Top Section Height	Bottom Section Height	Notes
4642 P (6-1/2" Top)	3-5/8"	16-3/8"	3-1/2" x 48", 3-1/2" x 60"
4642 P (10" Top)	3-5/8"	16-3/8"	3-1/2" x 48", 3-1/2" x 60"
4642 P (13" Top)	3-5/8"	16-3/8"	3-1/2" x 60"
4610 P	-	28-3/8"	3-1/2" x 48", 3-1/2" x 60"
4661 P	-	40"	3" x 40"

Model	Top Section Height	Bottom Section Height	Notes
3642 (6-1/2" Top)	6-1/2"	20-1/4"	3" x 48", 3" x 60"
3642 (10" Top)	10"	17-3/4"	3" x 60"
3642 (13" Top)	13"	26-3/4"	3" x 60"
3610	-	19-5/8"	3" x 48", 3" x 60"

Dowel is Sent Loose

4642
 Now Available
 With or without
 Crosshatch
 Acorn Top
 With Special Order

Newels

Balusters

This Series Available in octagon by special order.

Carolina

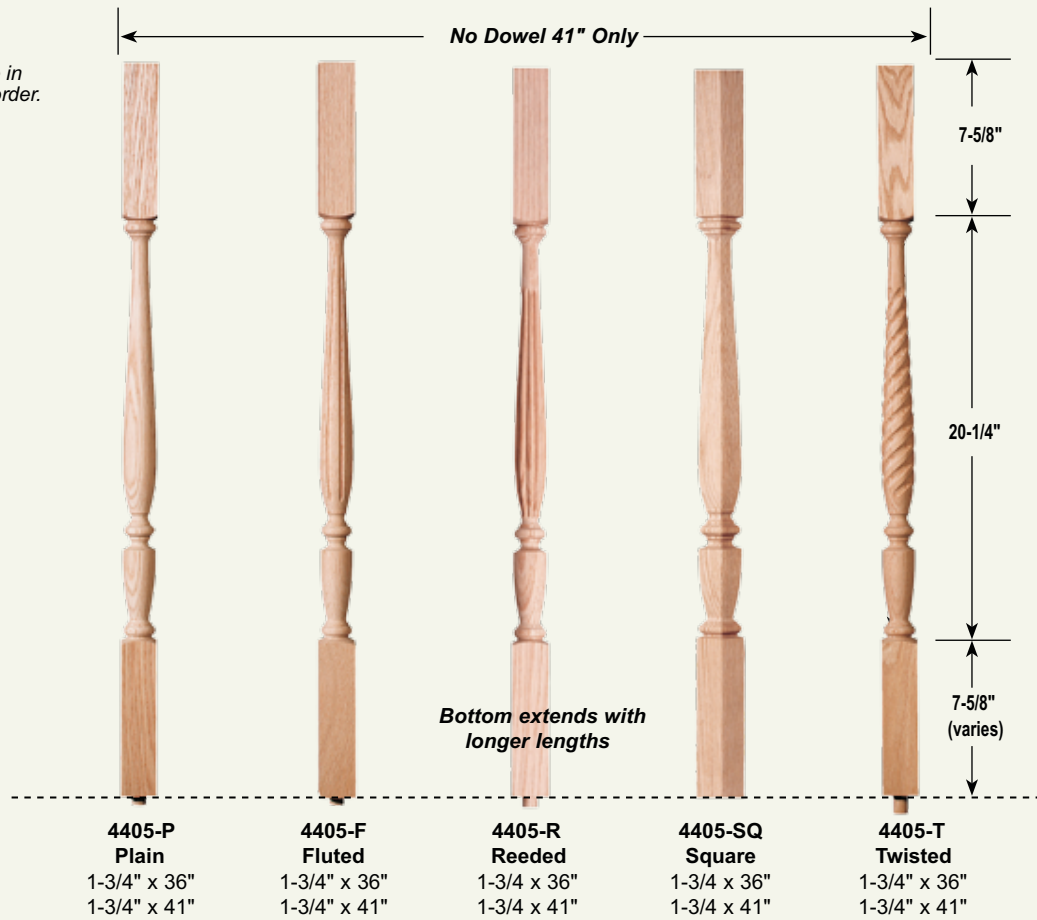

This Series Available in octagon by special order.



4442
Now Available
With or without
Crosshatch
Acorn Top
With Special Order

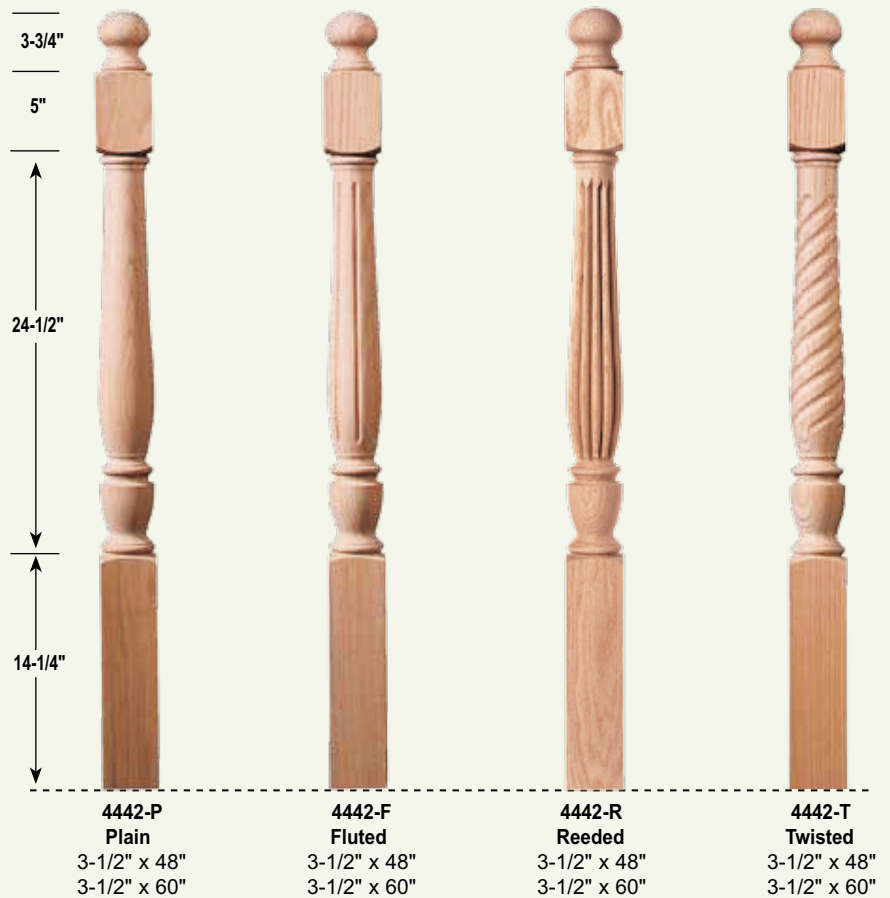

Newels

Balusters

Top extends with longer lengths

5" Straight Section

10-1/2"

4-1/4"

7-5/8"

10-1/2"

4415-LB 41" Available in Plain, Twisted, Fluted or Reeded (No Dowel)	4415-P Plain 1-3/4" x 3X" 1-3/4" x 39" 1-3/4" x 41"	4415-F Fluted 1-3/4" x 3X" 1-3/4" x 39" 1-3/4" x 41"	4415-R Reeded 1-3/4" x 3X" 1-3/4" x 39" 1-3/4" x 41"	4415-T Twisted 1-3/4" x 3X" 1-3/4" x 39" 1-3/4" x 41"	4417-F Fluted 1-3/4" x 41" LB (No Dowel) Also Available in Plain	4417-R Reeded 1-3/4" x 41" LB
---	--	---	---	--	---	--

Carolina

25-7/8"

21-1/4"

25-3/4"

14-1/4"

4410-P Plain 3-1/2" x 48" 3-1/2" x 60"	4410-F Fluted 3-1/2" x 48" 3-1/2" x 60"	4410-R Reeded 3-1/2" x 48" 3-1/2" x 60"	4410-T Twisted 3-1/2" x 48" 3-1/2" x 60"	4461-P Plain 3" x 41" Dowel is sent loose.	4461-F Fluted 3" x 41"	4461-R Reeded 3" x 41"	4461-T Twisted 3" x 41"
--	---	---	--	--	-------------------------------------	-------------------------------------	--------------------------------------

Newels

Balusters

Square Savannah

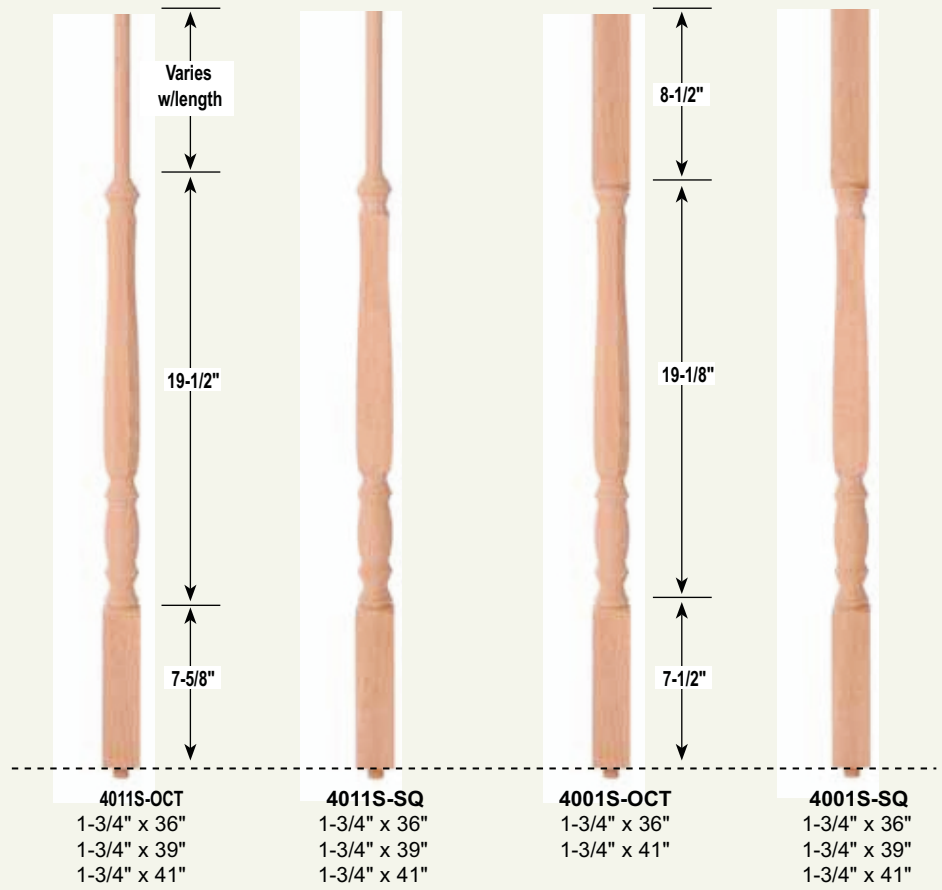

Newels

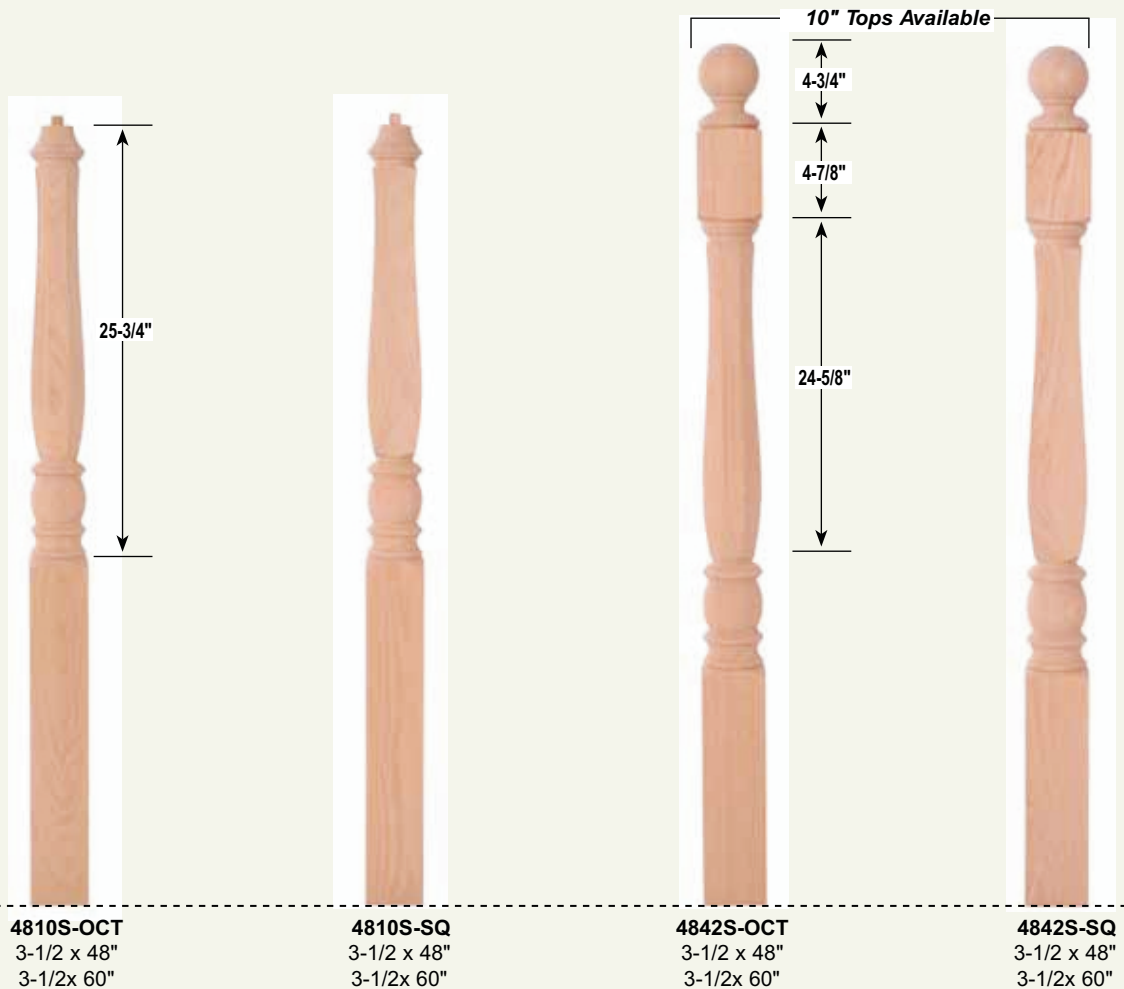

Balusters

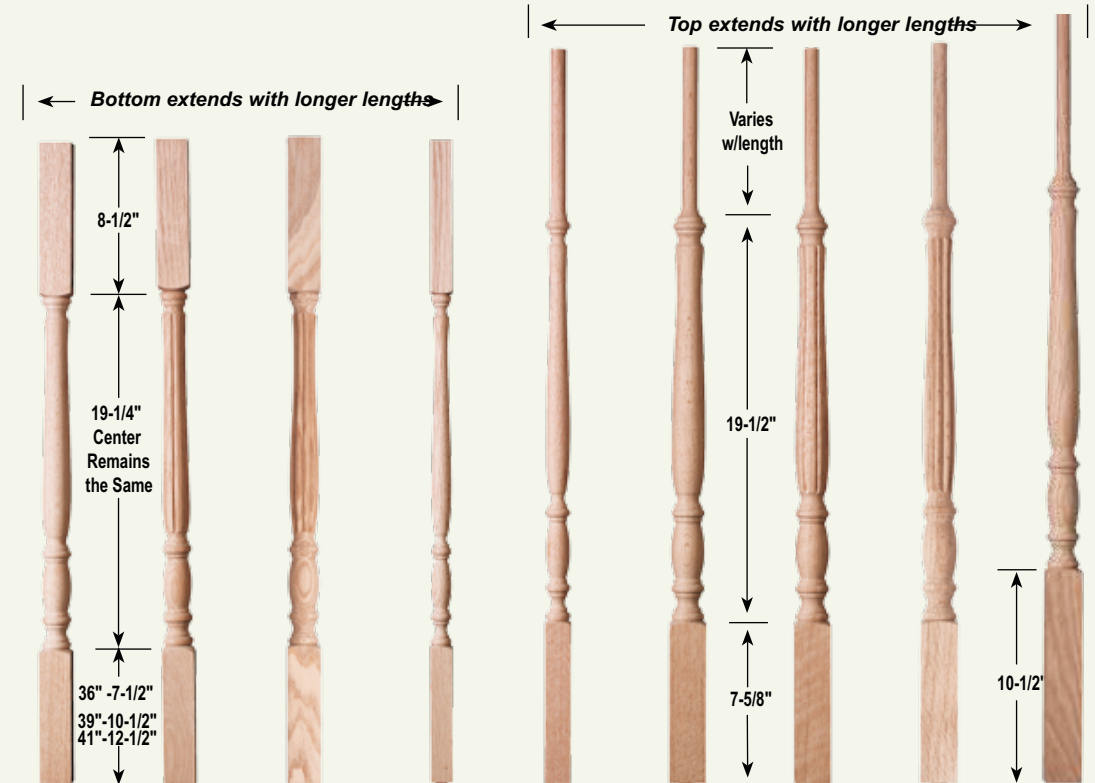

4001-P 1-3/4" x 36" 1-3/4" x 41" (No Dowel)	4001-F 1-3/4" x 36" 1-3/4" x 41" (No Dowel)	4001-R 36" 1-3/4" x 36" 1-3/4" x 41" (No Dowel)	5001-P or F 1-1/4" x 36" 1-1/4" x 39" 1-1/4" x 41" (No Dowel)	5011-P 1-1/4" x 36" 1-1/4" x 39" 1-1/4" x 41"	4011-P 1-3/4" x 36" 1-3/4" x 39" 1-3/4" x 41"	4011-F 1-3/4" x 36" 1-3/4" x 39" 1-3/4" x 41"	4011-R 1-3/4" x 36" 1-3/4" x 39" 1-3/4" x 41"	4011-LB 41" Available Plain or Fluted (No Dowel)
---	---	--	--	---	---	---	---	--



Savannah



4842 Now Available With or without Cross Hatch Acorn Top With Special Order	4842-P 3-1/2" x 48" 3-1/2" x 60"	4842-F 3-1/2" x 48" 3-1/2" x 60"	4842-P 10" Top 3-1/2" x 60"	4842-F 10" Top 3-1/2" x 60"	4842-R 3-1/2" x 48" 3-1/2" x 60"	4810-P 3-1/2" x 48" 3-1/2" x 60"	4810-F 3-1/2" x 48" 3-1/2" x 60"	4810-R 3-1/2" x 48" 3-1/2" x 60"	4861-P 3" x 40" 4861 Fluted and reeded also available
---	---	---	--	--	---	---	---	---	--

When ordering #4842 series,
please specify 5" or 10" top.
10" top available in 60" only.

3810
3" x 48"
3" x 60"

Newels

Balusters

Biltmore

Newels

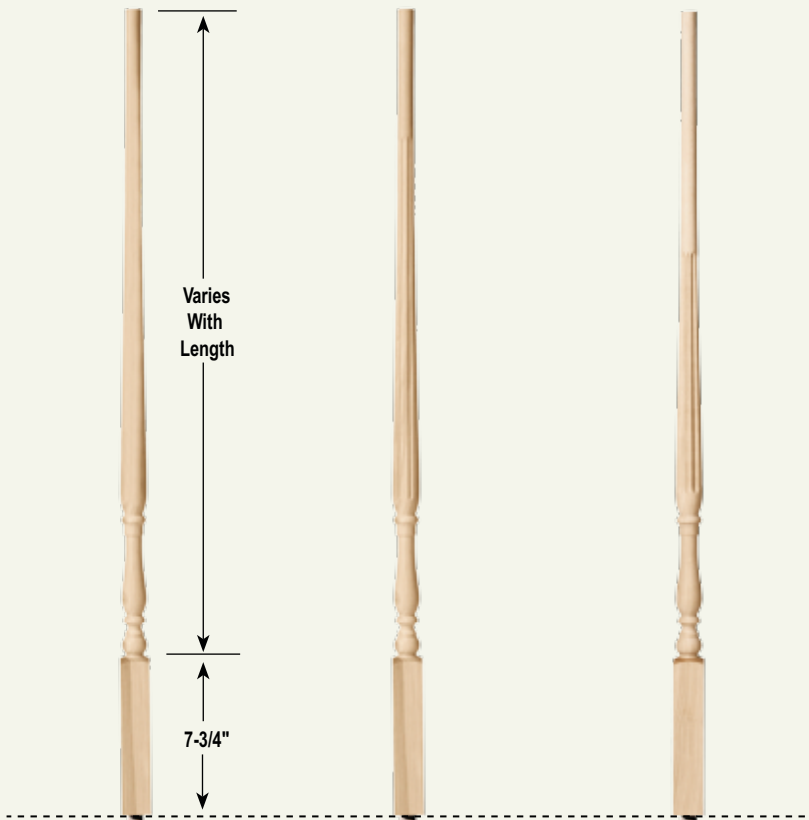

5715-P Plain
 1-1/2 or 1-3/4" x 3X"
 1-1/2 or 1-3/4" x 39"
 1-1/2 or 1-3/4" x 41"

5715-F Fluted
 1-1/2 or 1-3/4" x 3X"
 1-1/2 or 1-3/4" x 39"
 1-1/2 or 1-3/4" x 41"

5715-R Reeded
 1-1/2 or 1-3/4" x 3X"
 1-1/2 or 1-3/4" x 39"
 1-1/2 or 1-3/4" x 41"

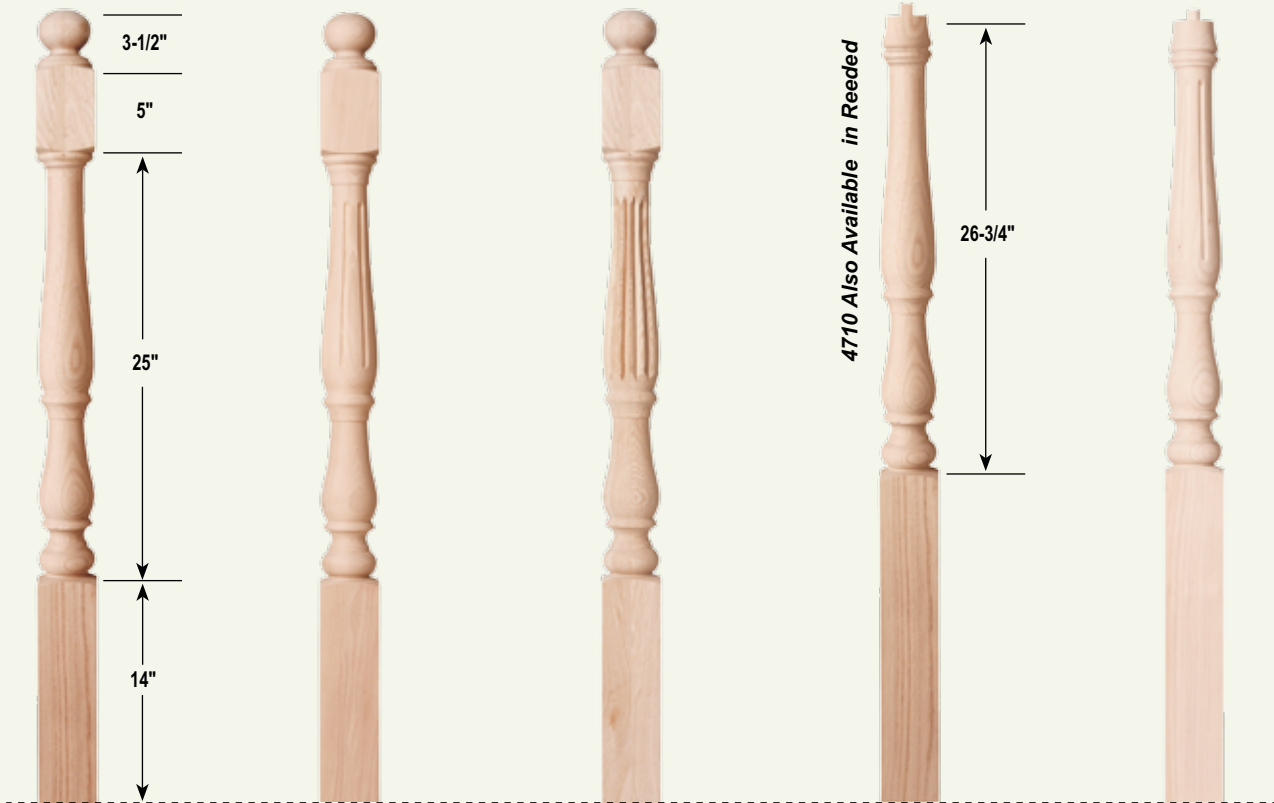

4742-P Plain
 3-1/4" x 48"
 3-1/4" x 60"

4742-F Fluted
 3-1/4" x 48"
 3-1/4" x 60"

4742-R Reeded
 3-1/4" x 48"
 3-1/4" x 60"

4710 Also Available in Reeded

4710-P Plain
 3-1/4" x 48"
 3-1/4" x 60"

4710-F Fluted
 3-1/4" x 48"
 3-1/4" x 60"

60" Available in 5", 10" or 13" Top Block Please specify when ordering.
 Newels Also Available in 3-1/2" by Special Order.

Balusters

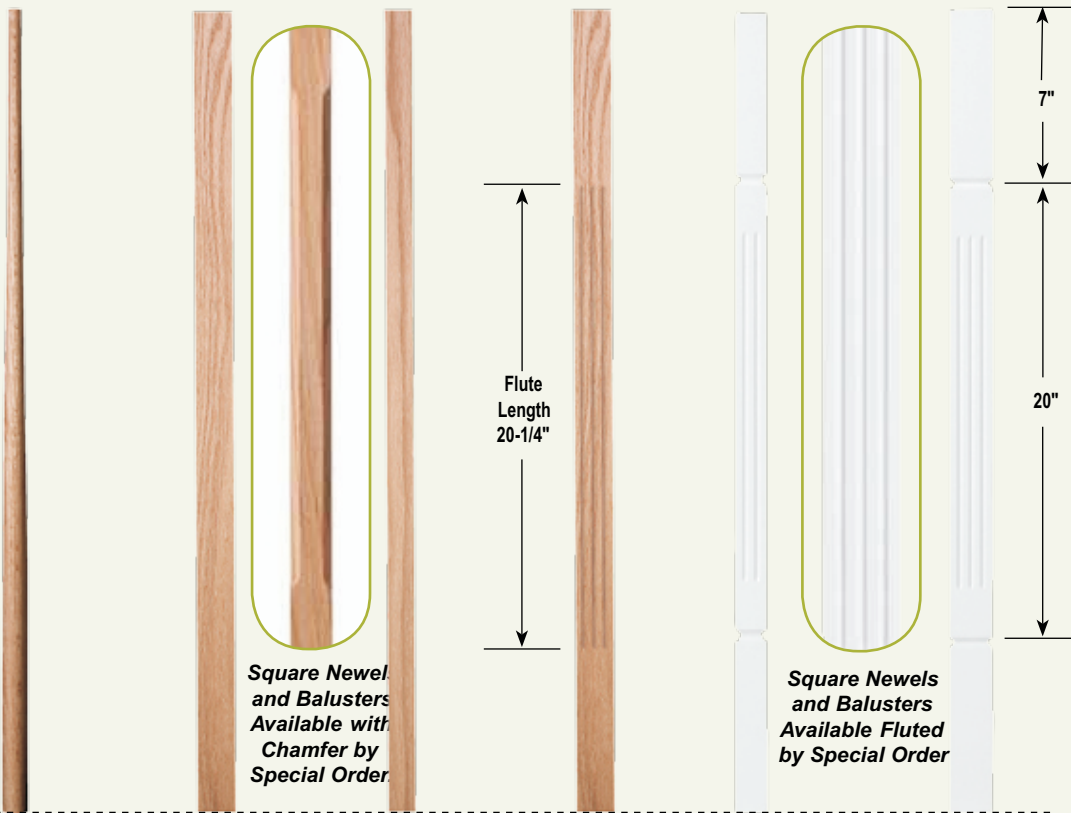

*Square Newel
and Balusters
Available with
Chamfer by
Special Order*

*Square Newels
and Balusters
Available Fluted
by Special Order*

0150-P	0175-P	0125-P	0175-F	0125-VFL	0175-VFL
Round Pool Cue	1-3/4" x 31"	1-1/4" x 31"	1-3/4" x 31"	1-1/4" x 31"	1-3/4" x 31"
1-3/16" x 36"	1-3/4" x 34"	1-1/4" x 34"	1-3/4" x 34"	1-1/4" x 34"	1-3/4" x 34"
1-3/16" x 39"	1-3/4" x 36"	1-1/4" x 36"	1-3/4" x 36"	1-1/4" x 36"	1-3/4" x 36"
1-3/16" x 41"	1-3/4" x 39"	1-1/4" x 39"	1-3/4" x 39"	1-1/4" x 39"	1-3/4" x 39"
Includes Dowel	1-3/4" x 41"	1-1/4" x 41"	1-3/4" x 41"	1-1/4" x 41"	1-3/4" x 41"

Available in most species

Contemporary

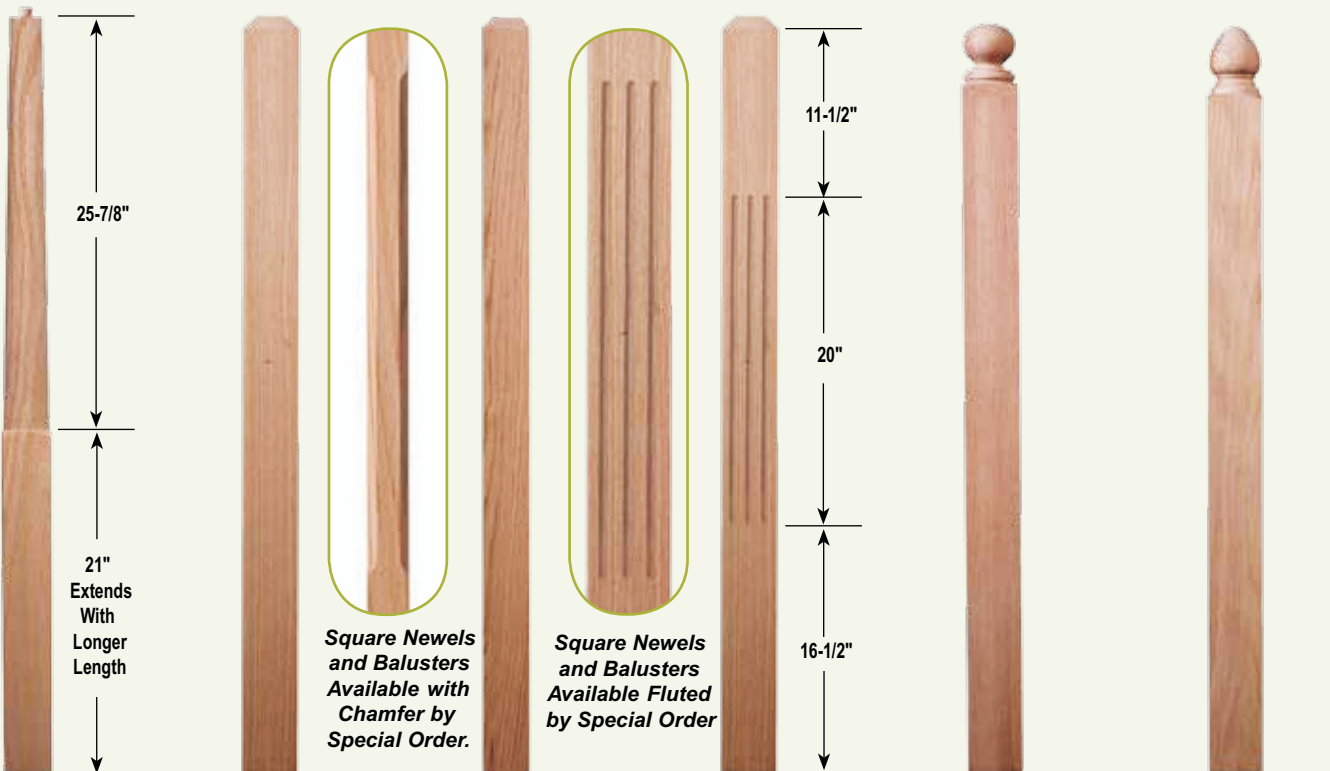

*Square Newels
and Balusters
Available with
Chamfer by
Special Order.*

*Square Newels
and Balusters
Available Fluted
by Special Order*

4050-A	4003-P	4002-P	4002 and 4003	4004-BT	4004-TD
3" x 48"	3-1/2" x 48"	3" x 48"	Available Fluted by Special Order	3" or 3-1/2" x 48"	3" or 3-1/2" x 48"
3" x 60"	3-1/2" x 60"	3" x 60"		4005BT	4005TD
4050-B				3" or 3-1/2" x 60"	3" or 3-1/2" x 60"
3-1/2" x 48"				4006BT	4006TD
3-1/2" x 60"				3" or 3-1/2" x 72"	3" or 3-1/2" x 72"

By Special Order Only

Also available in Mushroom Tops

Newels

Victorian Newels

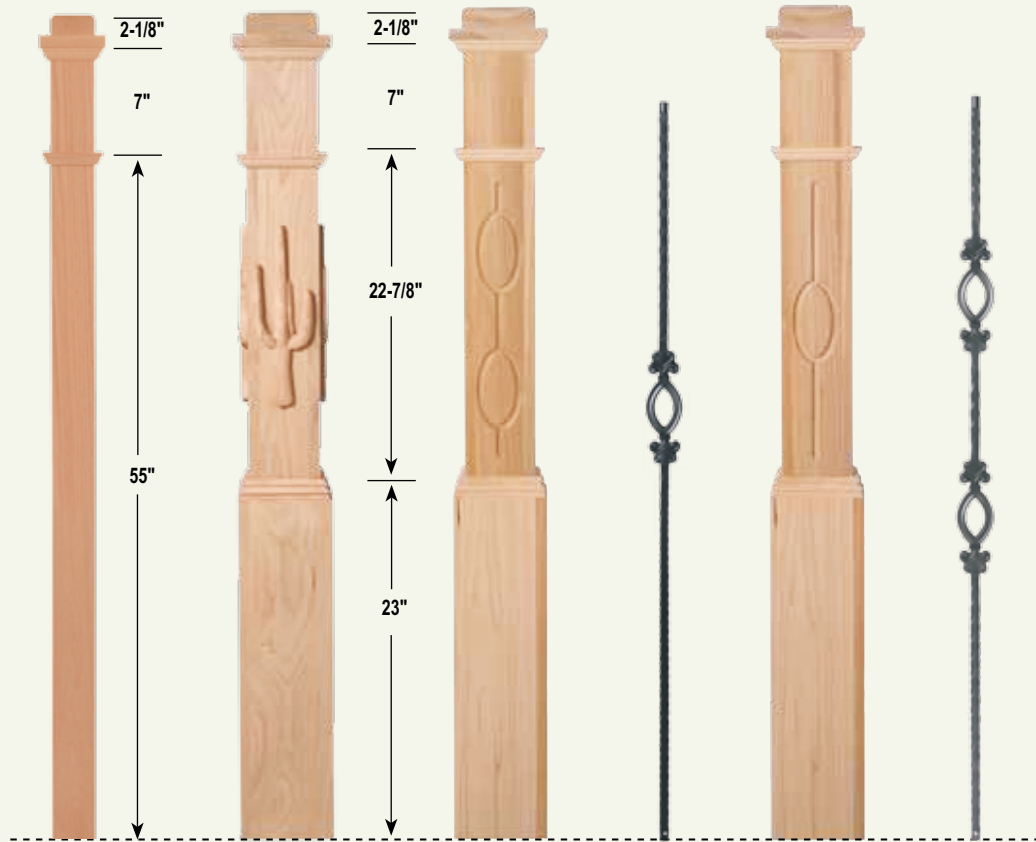

4075
62-1/8"
BaseWidth:
3-1/2" Square

4097-CUS
We can apply
virtually any
applique. Call for
pricing.

CS120

CS 2.9.5
Ends: 9/16"
Ht: 44"
Wt: 3.5 lbs.

CS121

CS 2.9.6
Ends: 9/16"
Ht: 44"
Wt: 3.8 lbs.



**4091-RP
and
4095-RP**

**4091-FP
and
4095-FP**

**4091-FL
and
4095-FL**

**4091-PL
and
4095-PL**

**4092-FL
and
4092-PL**

**4392-FL
4392-PL
4392-RP
4392-FP**

Cap Options

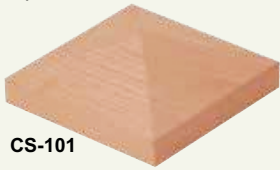

CS-101



CS-102

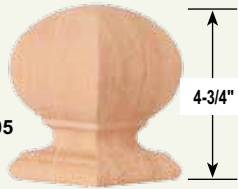

CS-105

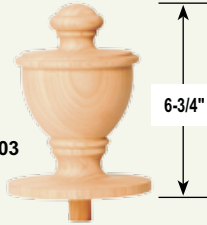

CS-103

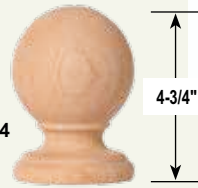

CS-104



4091 or 4095
EZ Mount
Box Newel
Mount

4091 Caps for Box Newels.
Can make virtually any fitting.
Can make to fit 4091, 4092, 4095 or 4392
Customer must specify



BNC-19



BNC-20



BNC-21

Accessories

Victorian Accessories

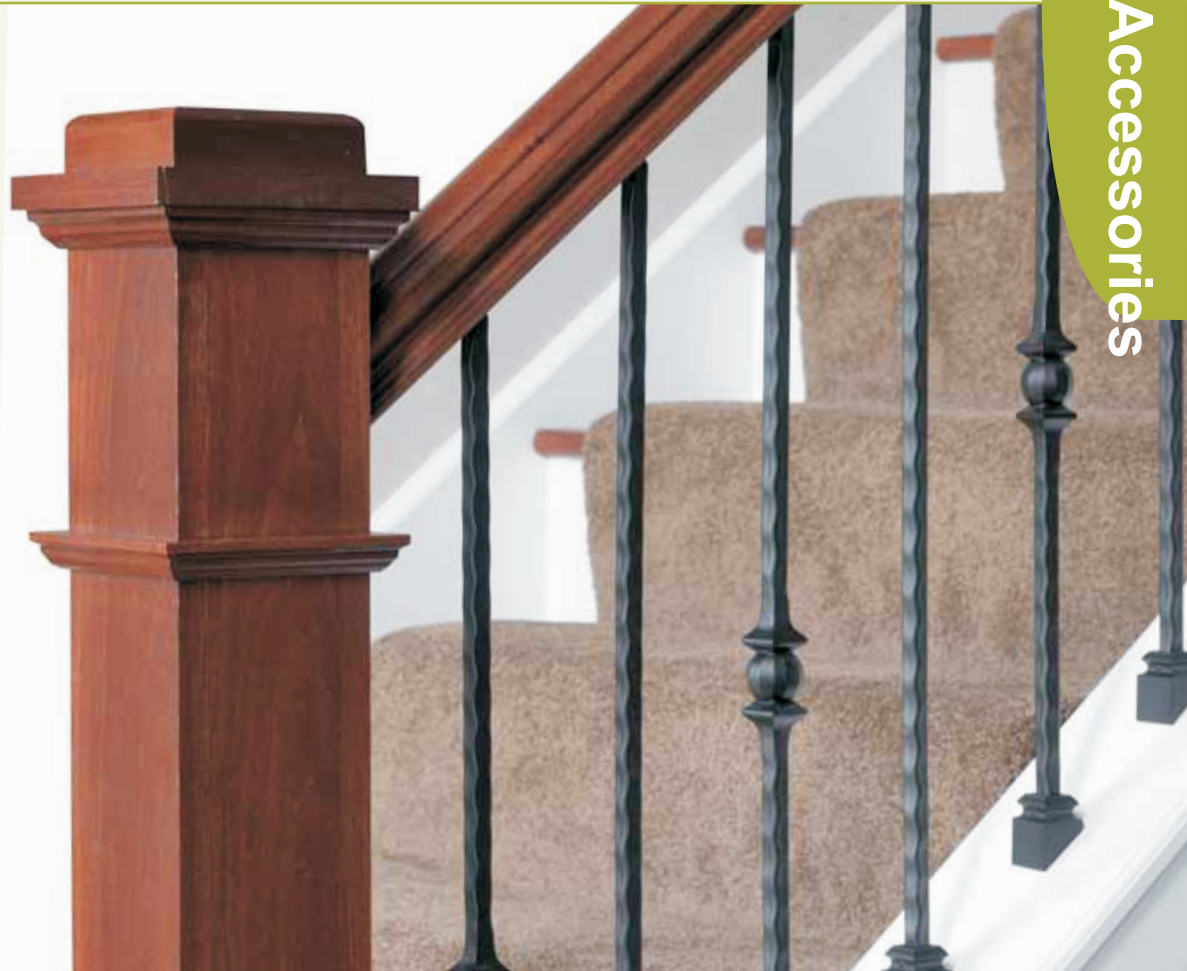

Accessories



1010
Flush Plug 1"



1020
Rail Bolt



1030
Wall Bracket

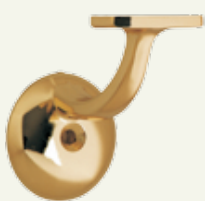

1032-HD
Wall Bracket

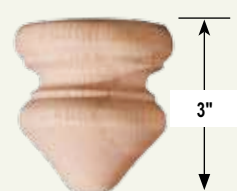

1070
Drop Cap
Available in 3" and 3-1/2" diameter

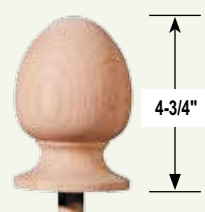

1075
Newel Finial

Items #1030 & 1032 available in the following finishes:
Bright Brass •Antique Brass
Dull Chrome •Satin Nickel •Satin Black



1060 Oval Rosette
5-1/2"H x 4-1/4"W
1064 Oval Rosette
6-1/2"H x 4-1/2"W



1063 Square Rosette
4-5/8"H x 6"W



1062
Round Rosette
4-3/8" Round

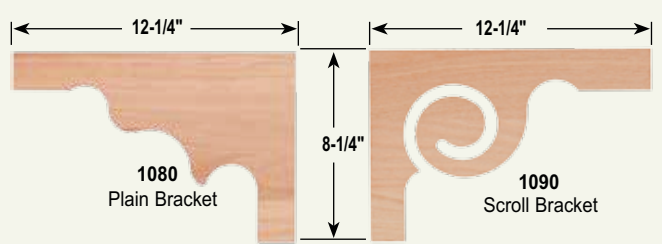

1080
Plain Bracket

1090
Scroll Bracket



1103
Newel Anchor



1104
Newel Anchors
3" & 3-1/2" Sizes Available



1106
Spin Driver
(to be used with Dowel Lockscrews)



1107
Dowel Lockscrews
(24 per pack)

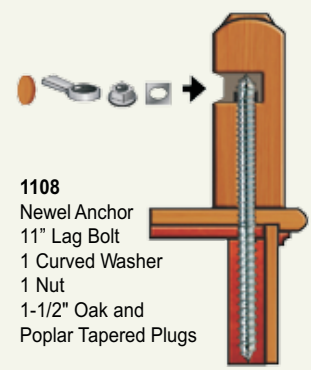

1108
Newel Anchor
11" Lag Bolt
1 Curved Washer
1 Nut
1-1/2" Oak and Poplar Tapered Plugs

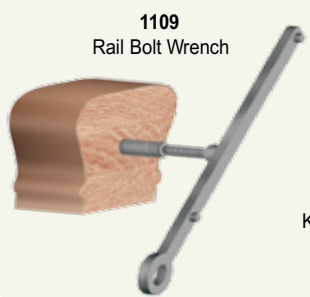

1109
Rail Bolt Wrench

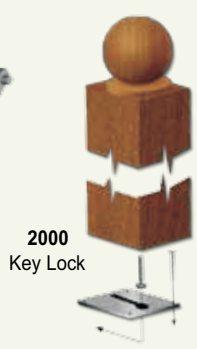

2000
Key Lock

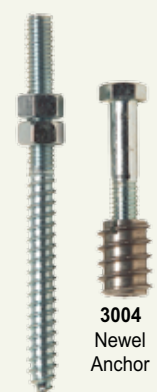

3004
Newel Anchor



3006
Newel Anchor



3007
Hardware Combination Kit

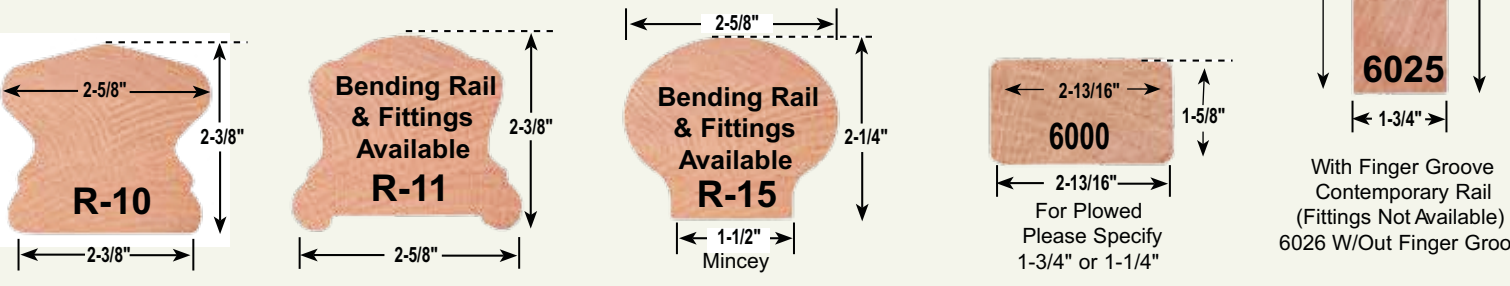
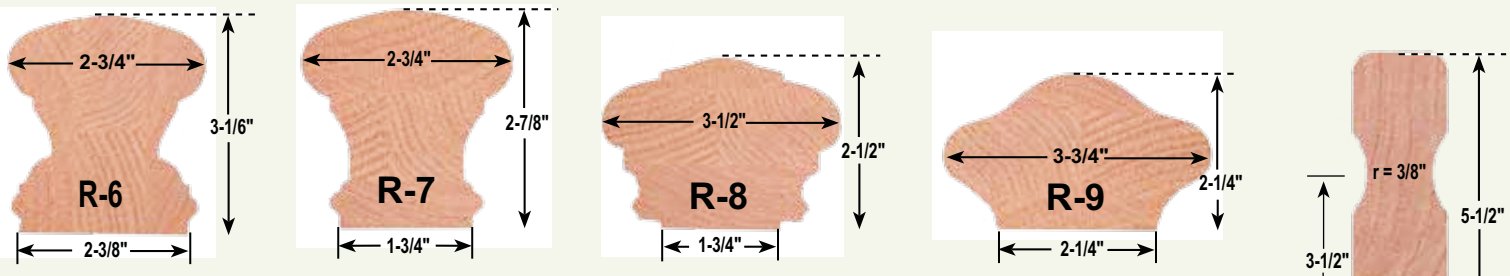
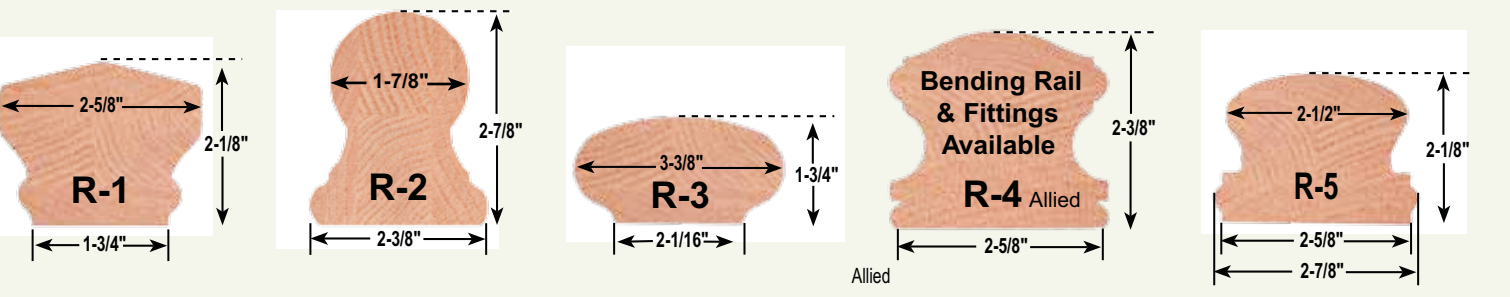
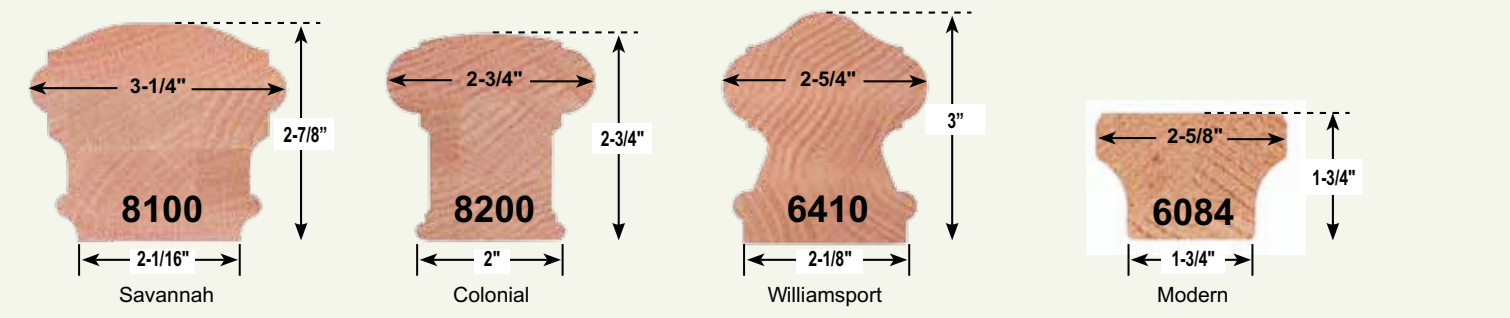
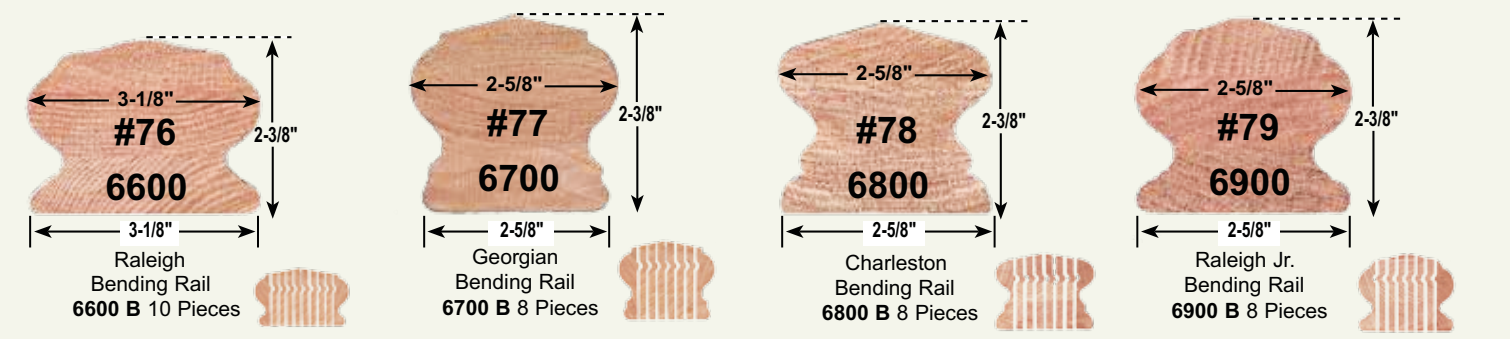
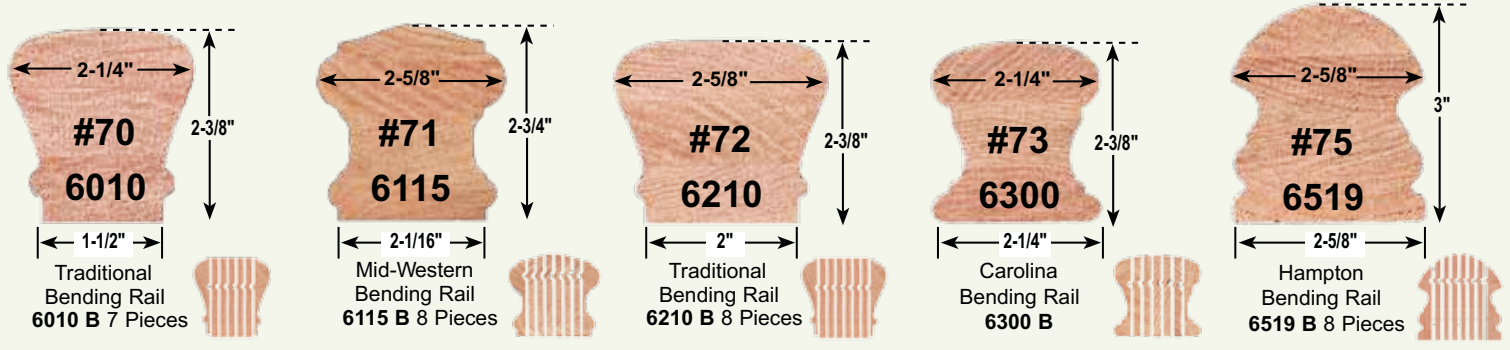

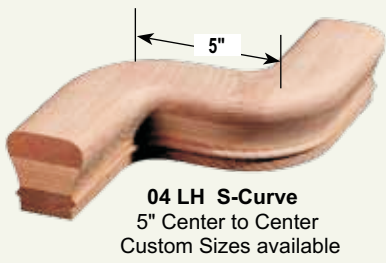

04 LH S-Curve
5" Center to Center
Custom Sizes available



05 RH S-Curve
5" Center to Center
Custom Sizes available



08
Coped End
Available 70 & 72
Series Only



09
Returned End



11
Level Quarterturn

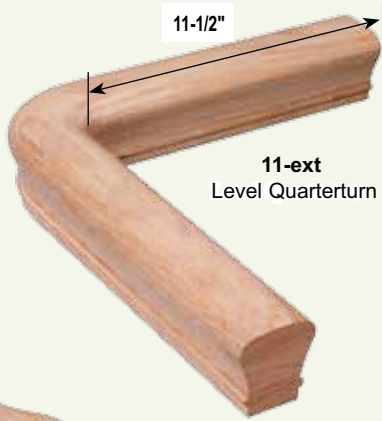

11-ext
Level Quarterturn



11
135 °
Quarterturn

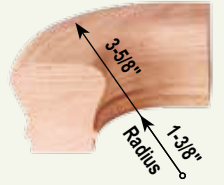

17
Radius Return End



20
Tandem Cap



21
Quarterturn
Cap

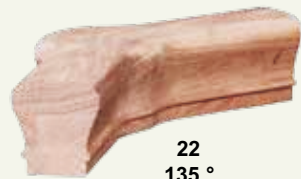

22
135 °
Quarterturn



50
Left Hand

55
Right Hand



71
Left Hand

76
Right Hand



60
Left Hand

65
Right Hand



97
2 Riser
(With Cap)

89
2 Riser
(with Tandem)

99
2 Riser
(No Cap)



7090

7095

7091

7092

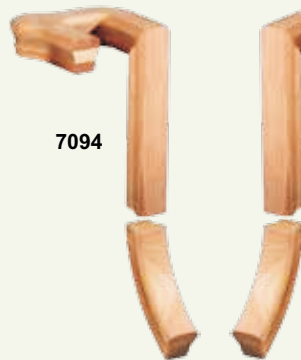

7094

7093

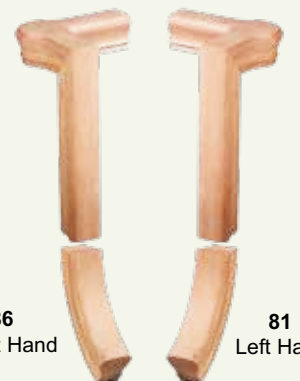

86
Right Hand

81
Left Hand

All goosenecks are shipped with easements unattached. Custom angles available on quarter turns.
Well hole fittings are 5-1/2" from Center of Rail to Center of Rail

Fittings are available in the following series: 70, 71, 72, 73, 75, 76, 77, 78, 79, R4, R11, R15 & 6042. Easements and Quarterturns



10
Starting Easing

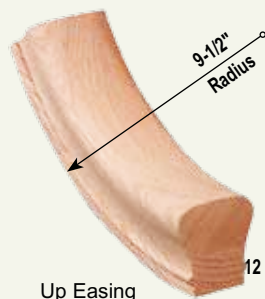

Up Easing

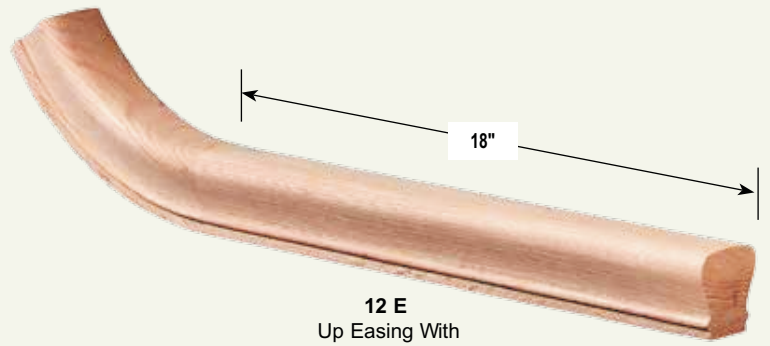

12 E
Up Easing With
Straight Extension

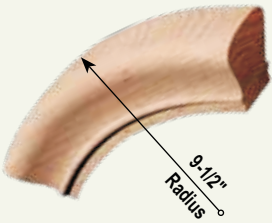

Over Easing

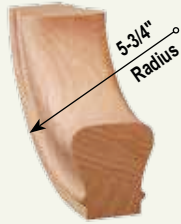

Up Easing 90°

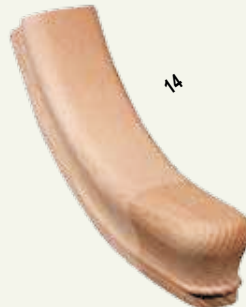

14



16
Over Easing
(Returned End)



36
Vertical Volute
Available 70 & 72 Series Only

15
Starting Easing
(Returned End)



19
Opening Cap



30
Left Hand Volute



35
Right Hand Volute



30-U
Universal Left Hand Volute



35-U
Universal Right Hand Volute

70 & 76 Series are 4-7/8" from center of newel to center of handrail.
All other profiles are 5-1/8".



40
Left Hand Turnout



45
Right Hand Turnout



41
Left Hand Turnout



46
Right Hand Turnout

4-7/8" From Center of Newel to Center of Handrail

2-7/8" From Center of Newel to Center of Handrail



8085
Nosing
1-1/16" x 1-1/2"

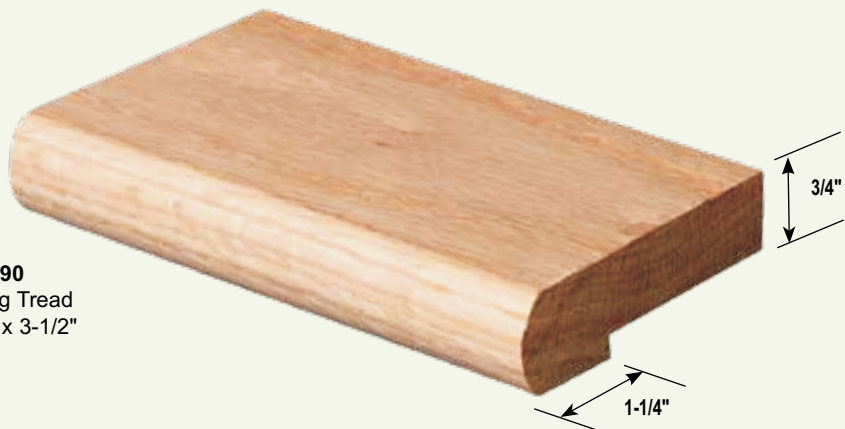

8090
Landing Tread
1-1/16" x 3-1/2"

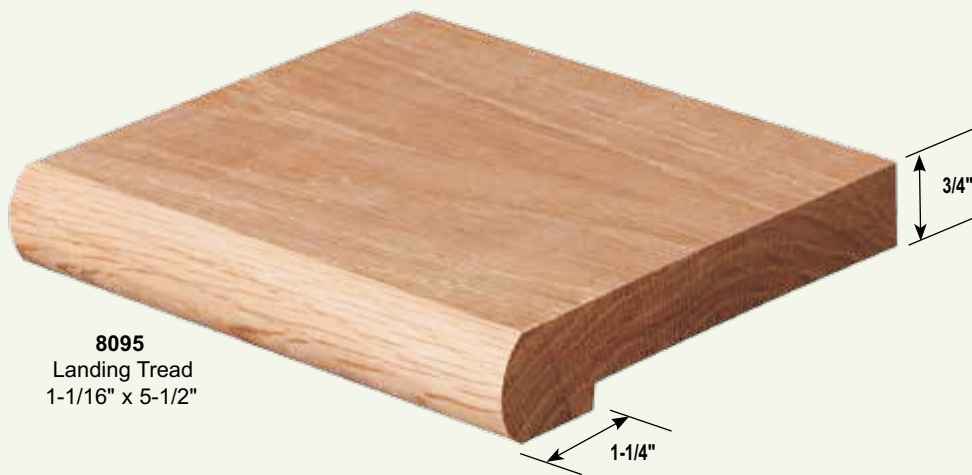

8095
Landing Tread
1-1/16" x 5-1/2"



6910 - Cove Mold
3/4" x 3/4"
6904 - Cove Mold
1/2" x 5/8"



6912
Stringer Mold
1-7/16" x 5/8"



6915
Stringer Cap
5/8" x 1/2"

Available
Sizes
1-1/2"
1-3/4"
2"
2-3/8"
2-7/8"
2-1/8"



RND-1
Round Rail
Special Order



6040
Wall Rail
1-1/2" x 1-1/2"



6042
Wall Rail
1-5/16" x 2-1/4"
Fittings Now Available
Easments & Quarterturns



6043
Wall Rail
1-3/4" x 1-5/8"



6044
Fusion Handrail
2-1/8"w x 2"h
7/8" Flat Bottom



1000
Fillet
3/16" x 1-1/4"
3/16" x 1-3/4"



1001
Shoe Rail
3/4" x 3-1/8" x 1-3/4" Plow
3/4" x 2-3/8" x 1-1/4" Plow



1002
Flat Fillet
3/16" x 1-1/4"
3/16" x 1-3/4"

8010 F
Reversible False End
Starting Step



8010
Reversible Single
"Bull Nose" Starting Step
Specify: 36", 42", 48", 54" or 60"
Measurement is distance from "notch to notch."
Also available in bowed front.

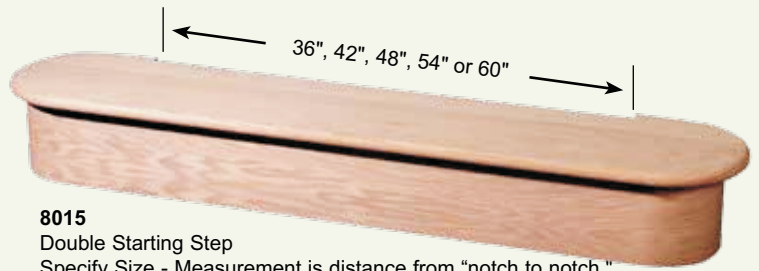

8015
Double Starting Step
Specify Size - Measurement is distance from "notch to notch."
Also available in bowed front.



8070
10-1/2" Tread
8071 11-1/2" Tread
Specify " 36", 42", 48" 54", 60" or 72"
Mitre Return: RH, LH or Double

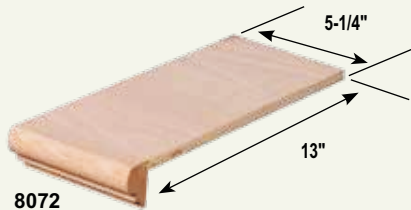

8072
False End
(No M.R.)

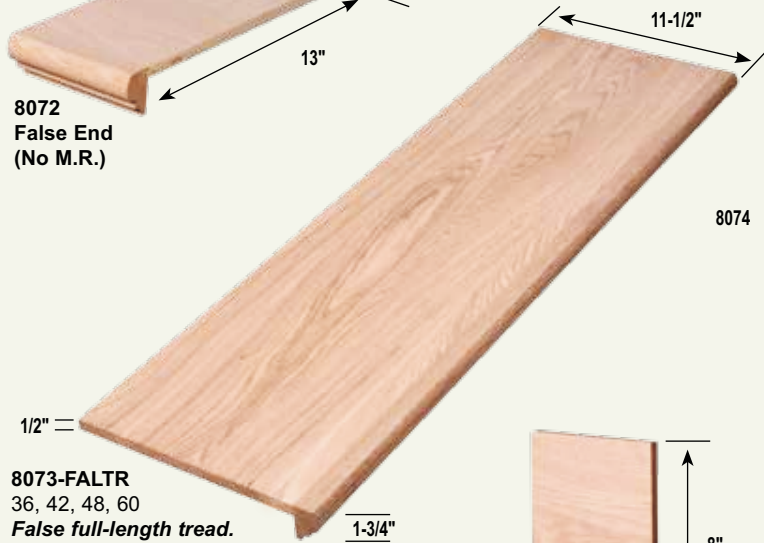

8074

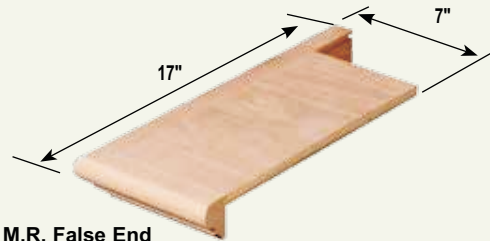

M.R. False End
Specify: RH or LH

8073-FALTR
36, 42, 48, 60
False full-length tread.
Left hand or right hand
available upon request.

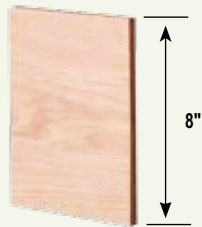

8076
False Riser
1/2" thick

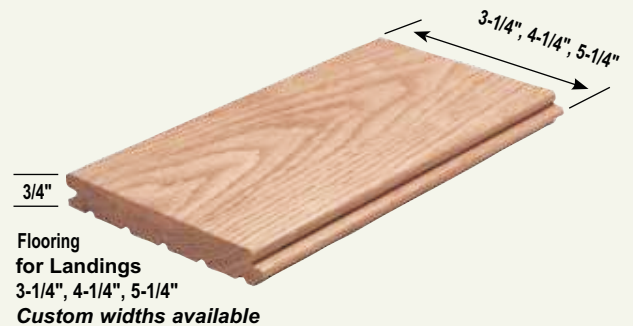

**Flooring
for Landings**
3-1/4", 4-1/4", 5-1/4"
Custom widths available



Winder Tread Panels
8078-TPNL
1" x 25" x 42"
1" x 25" x 48"
1" x 25" x 60"



97 "STR" Stringer
1" or 3/4" thick



8080
Riser
Specify Size:
3/4" x 36", 42", 48", 54" or 60"
1 x 8" S4S 1 x 6" S4S 1 x 4" S4S

Custom Profiles





Available in most species

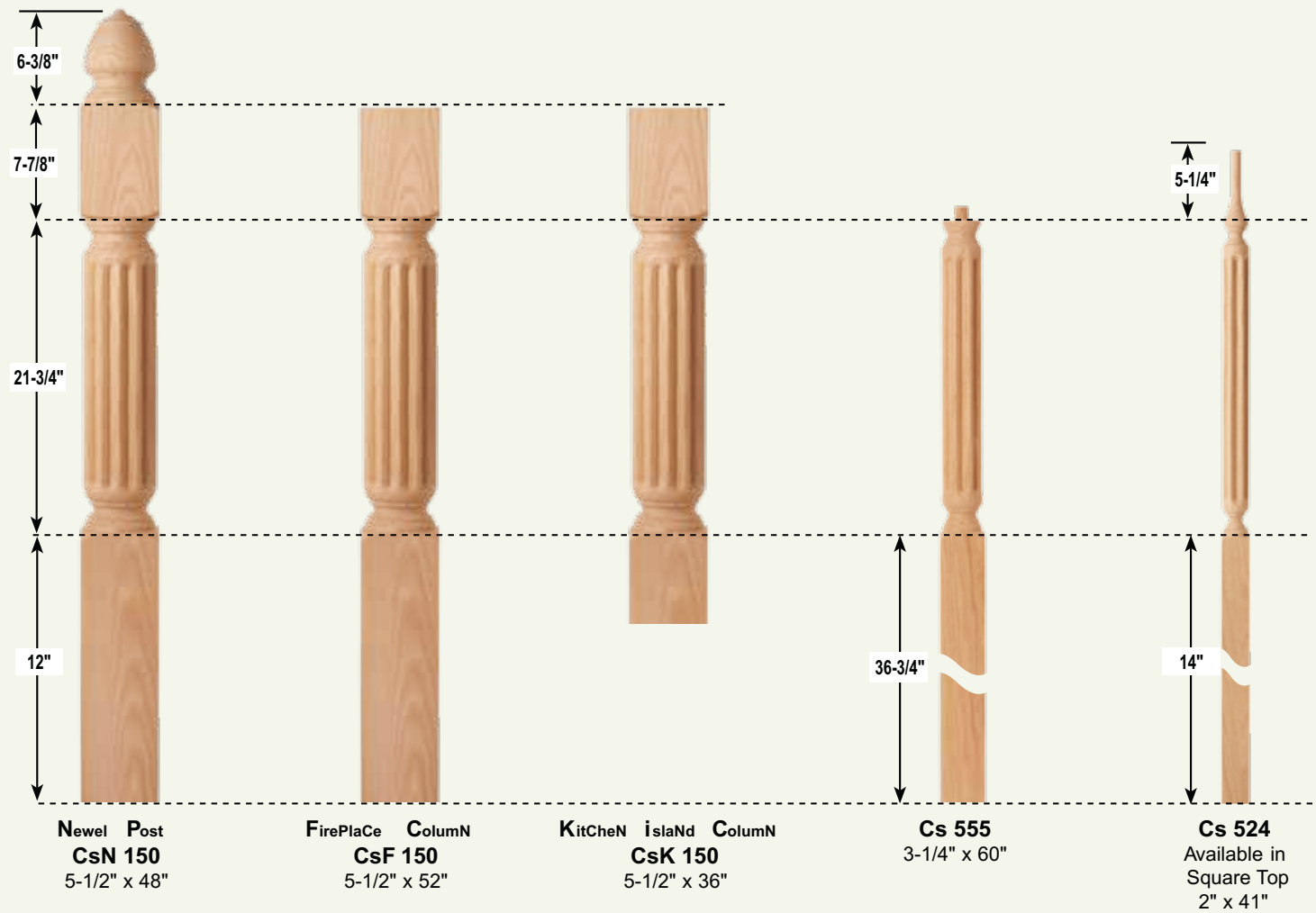

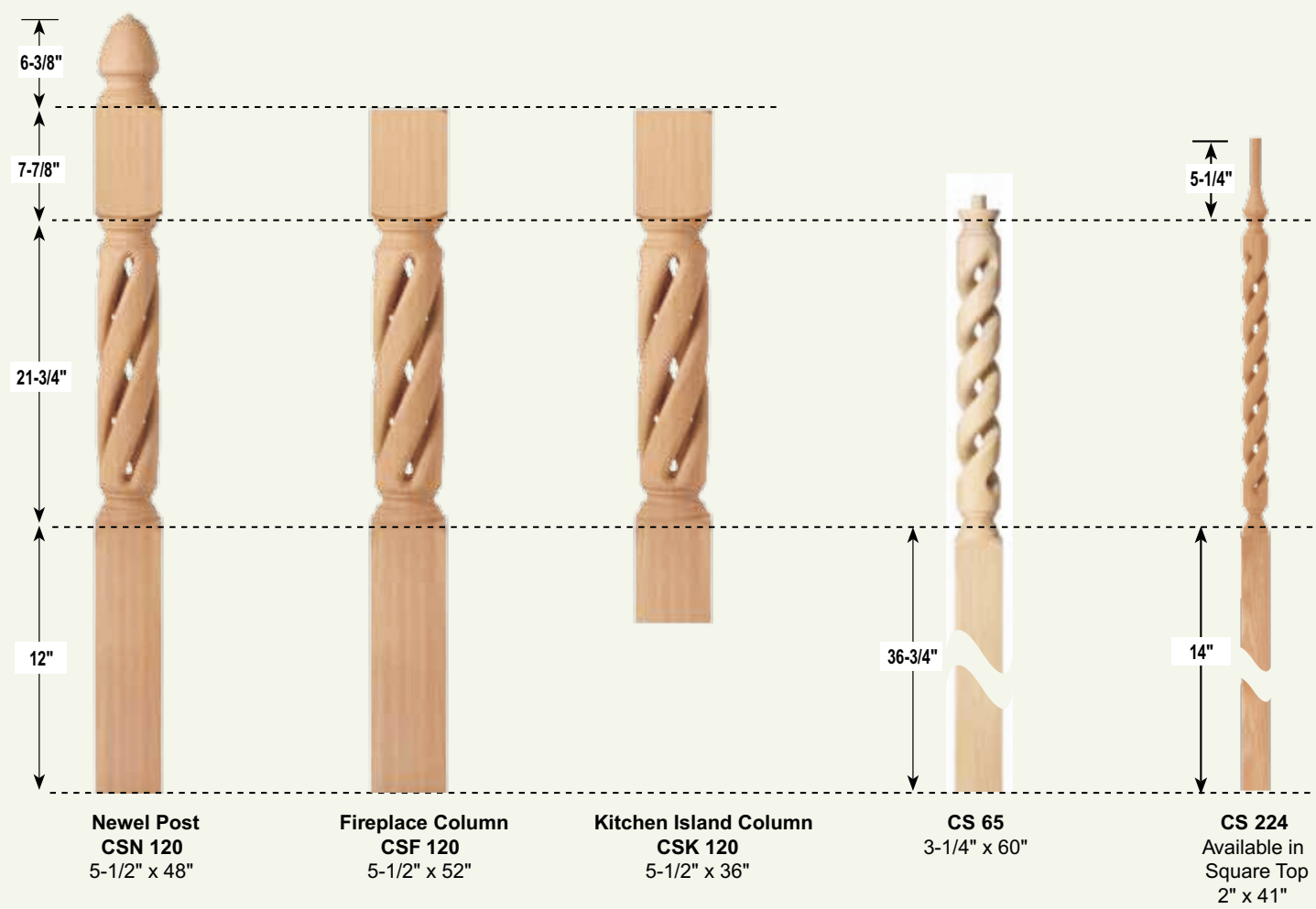
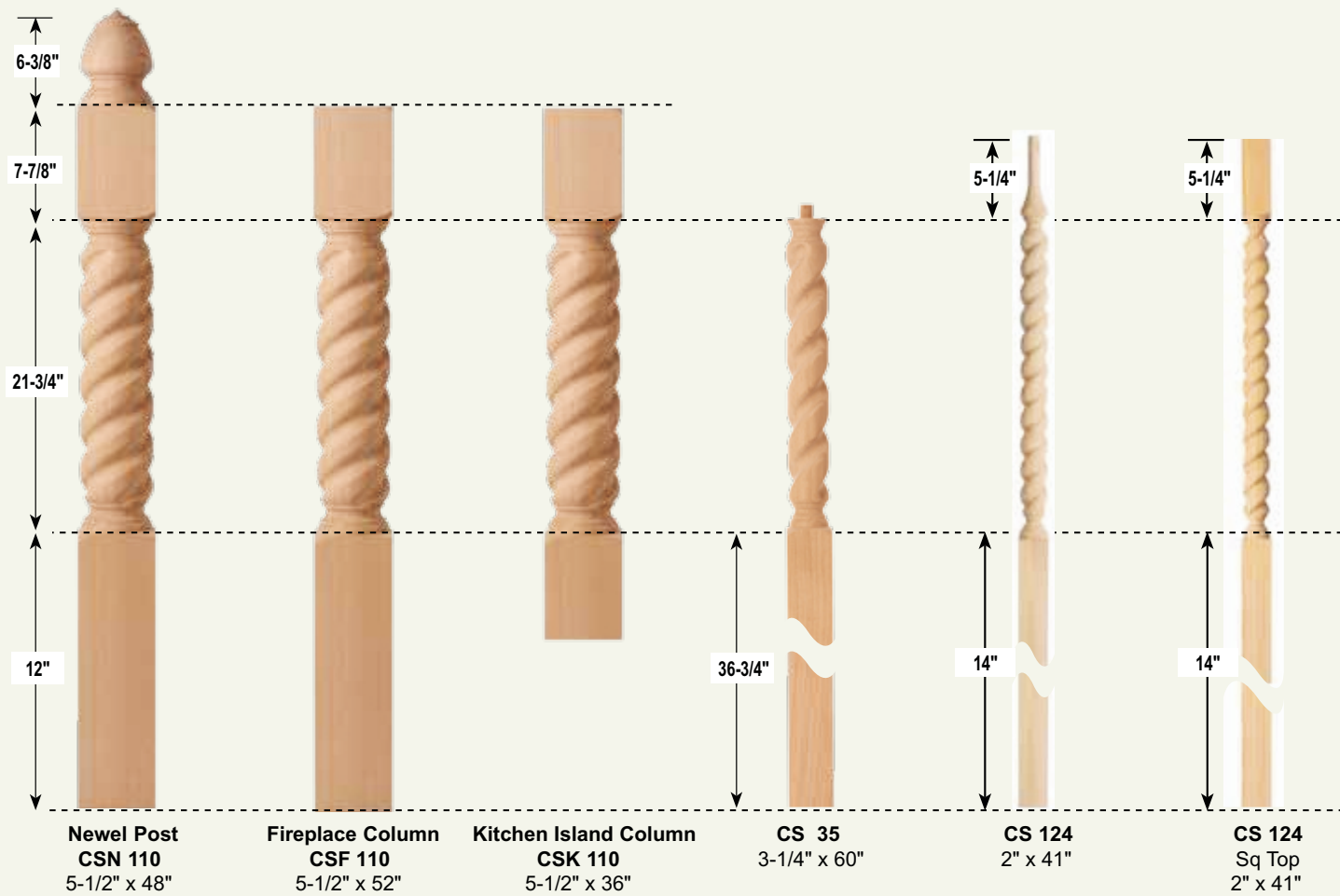

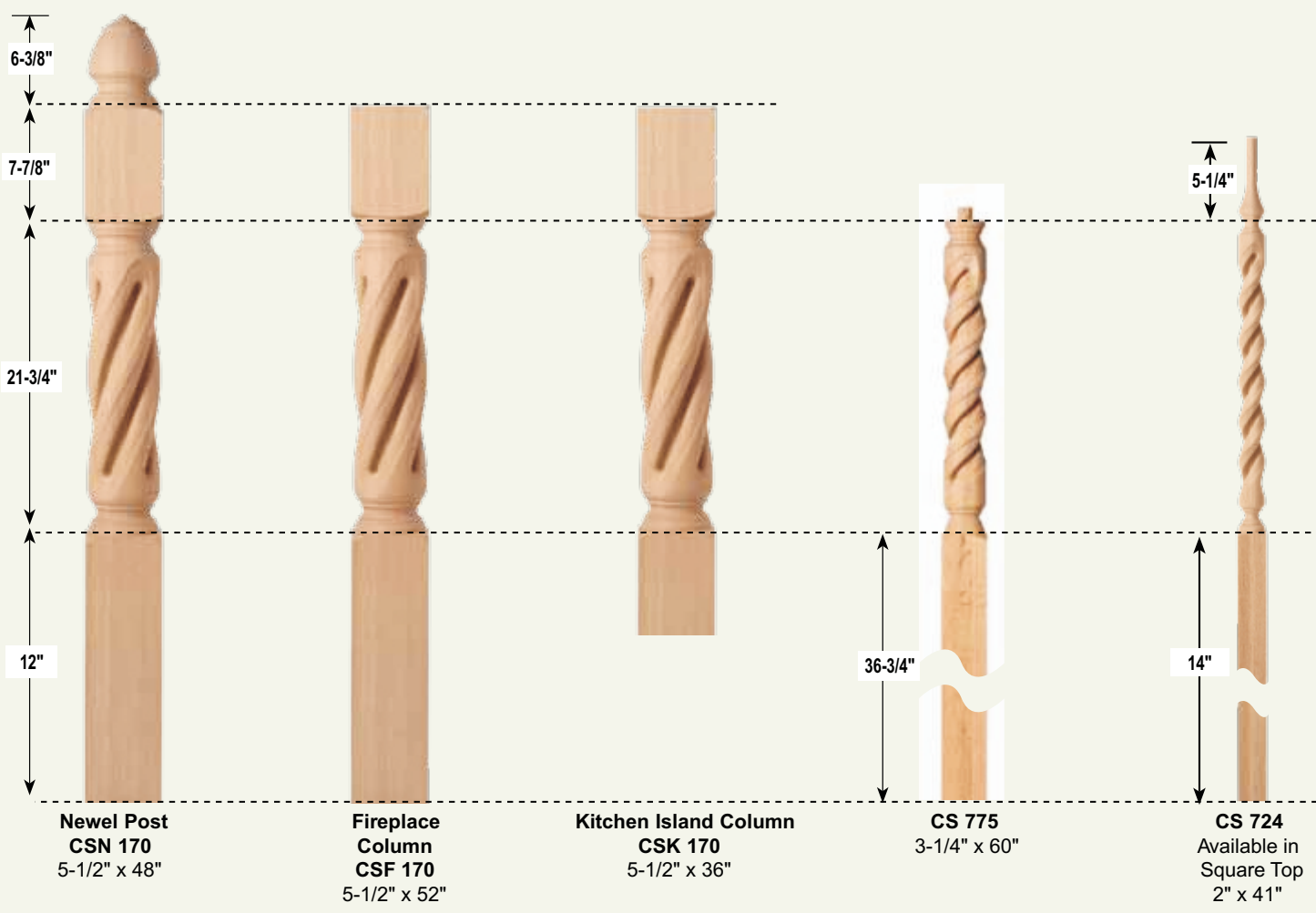
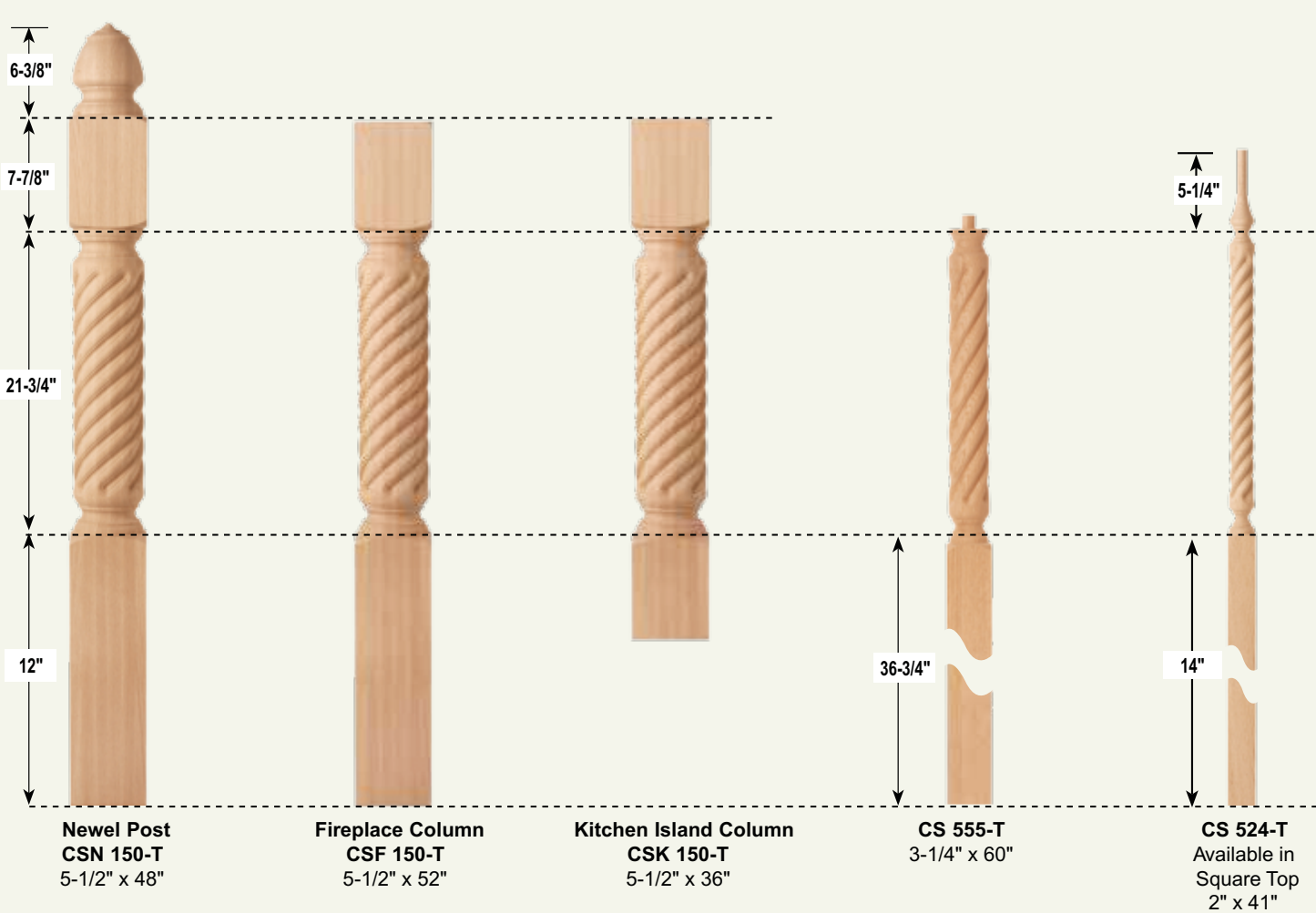

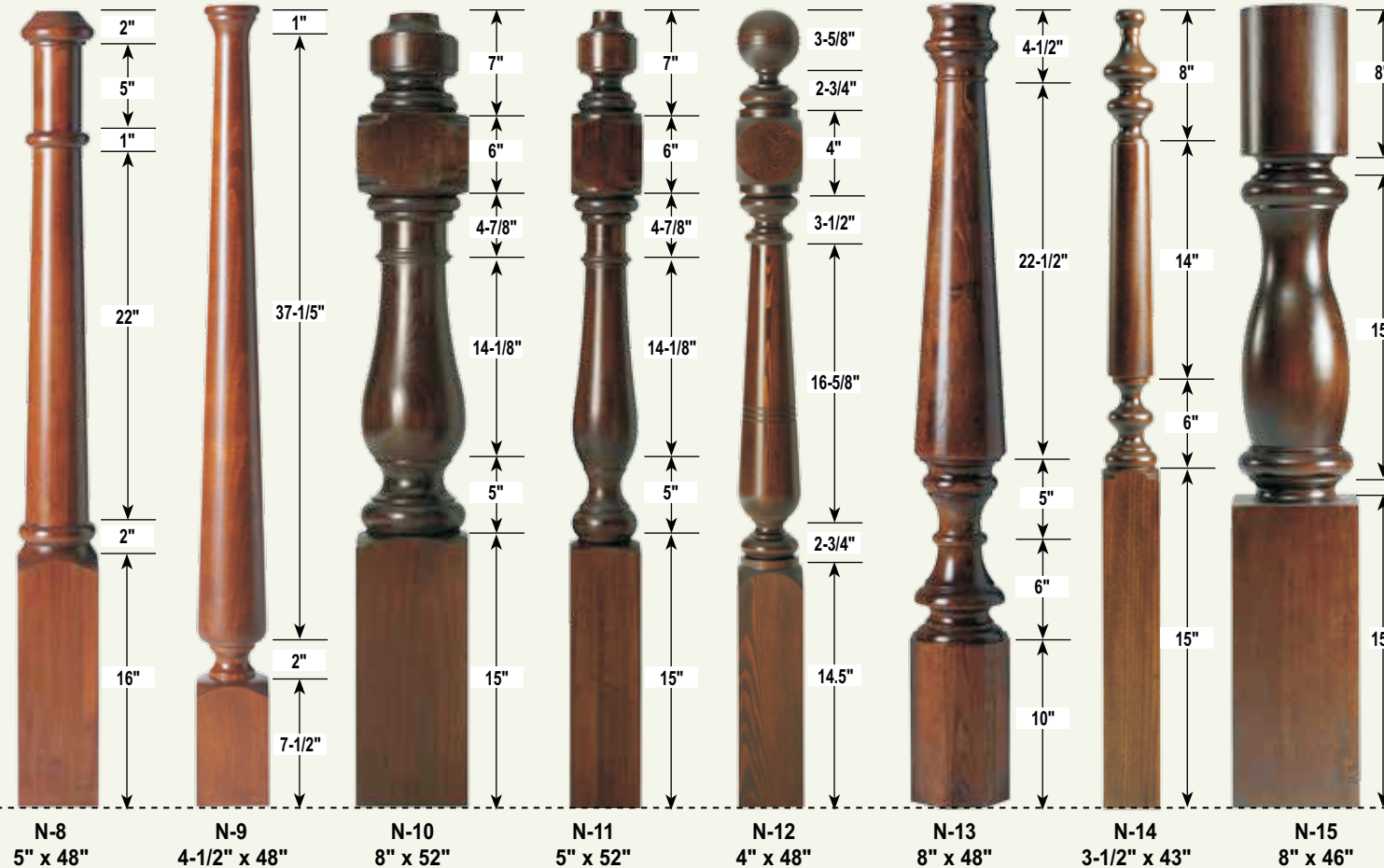
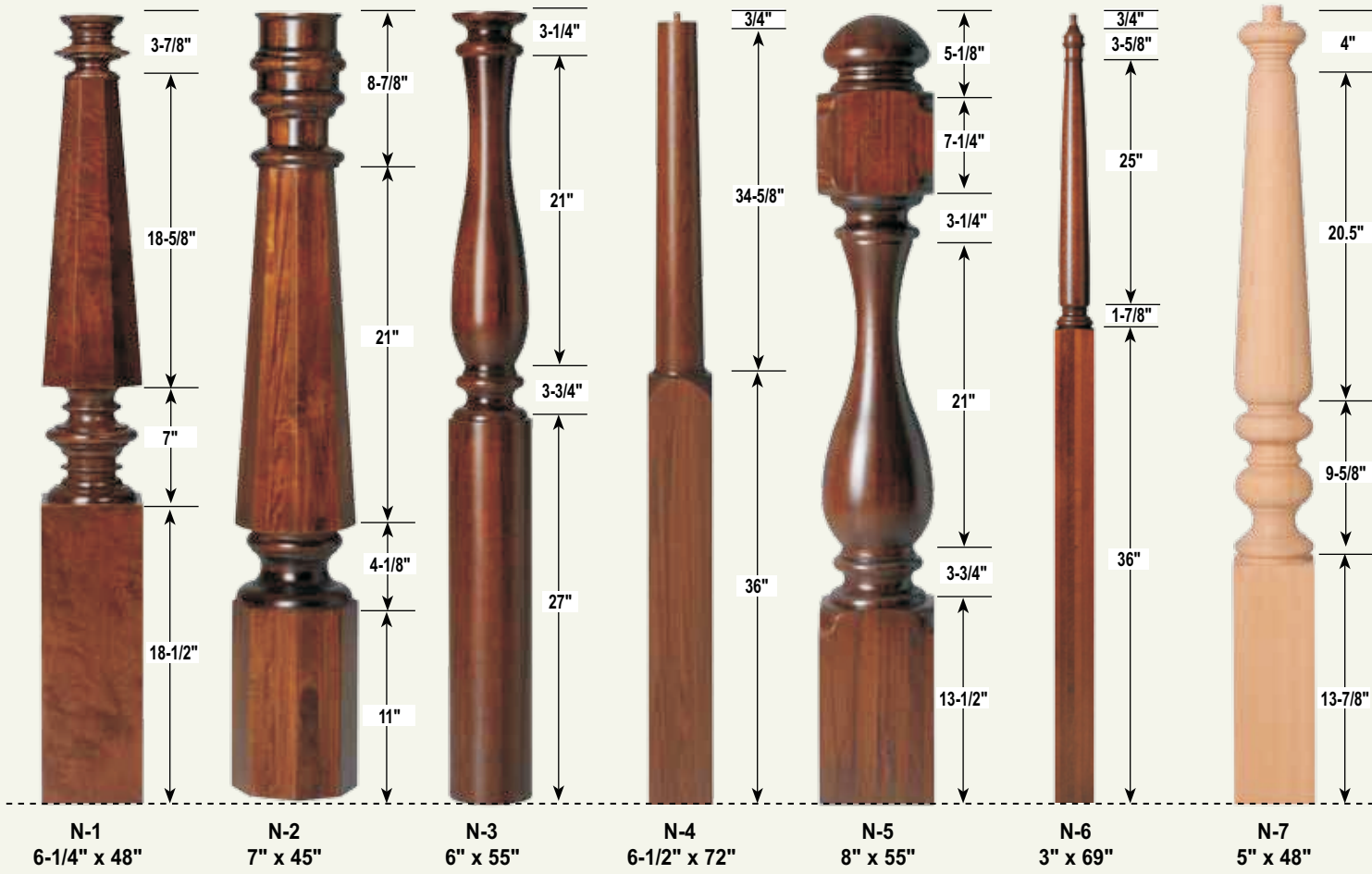

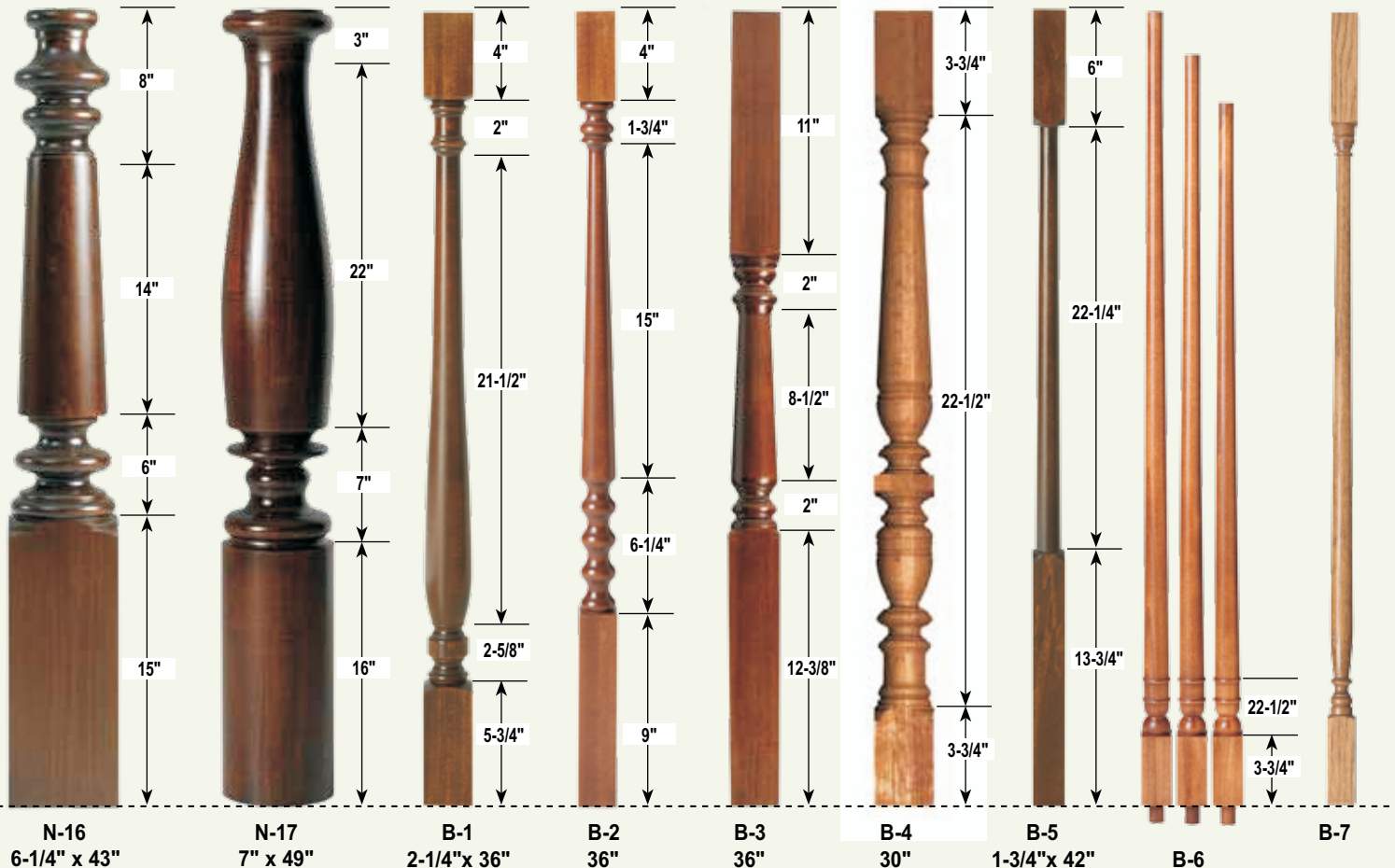

N-16 6-1/4" x 43"
N-17 7" x 49"
B-1 2-1/4" x 36"
B-2 36"
B-3 36"
B-4 30"
B-5 1-3/4" x 42"
B-6
B-7 36"



N-18 8" x 54"
N-19 48"
N-20 6-1/2" x 44"
N-21 4-5/8" x 48"
N-22 6" x 54"
N-23 7-1/2" x 51"
N-24 7" x 44"

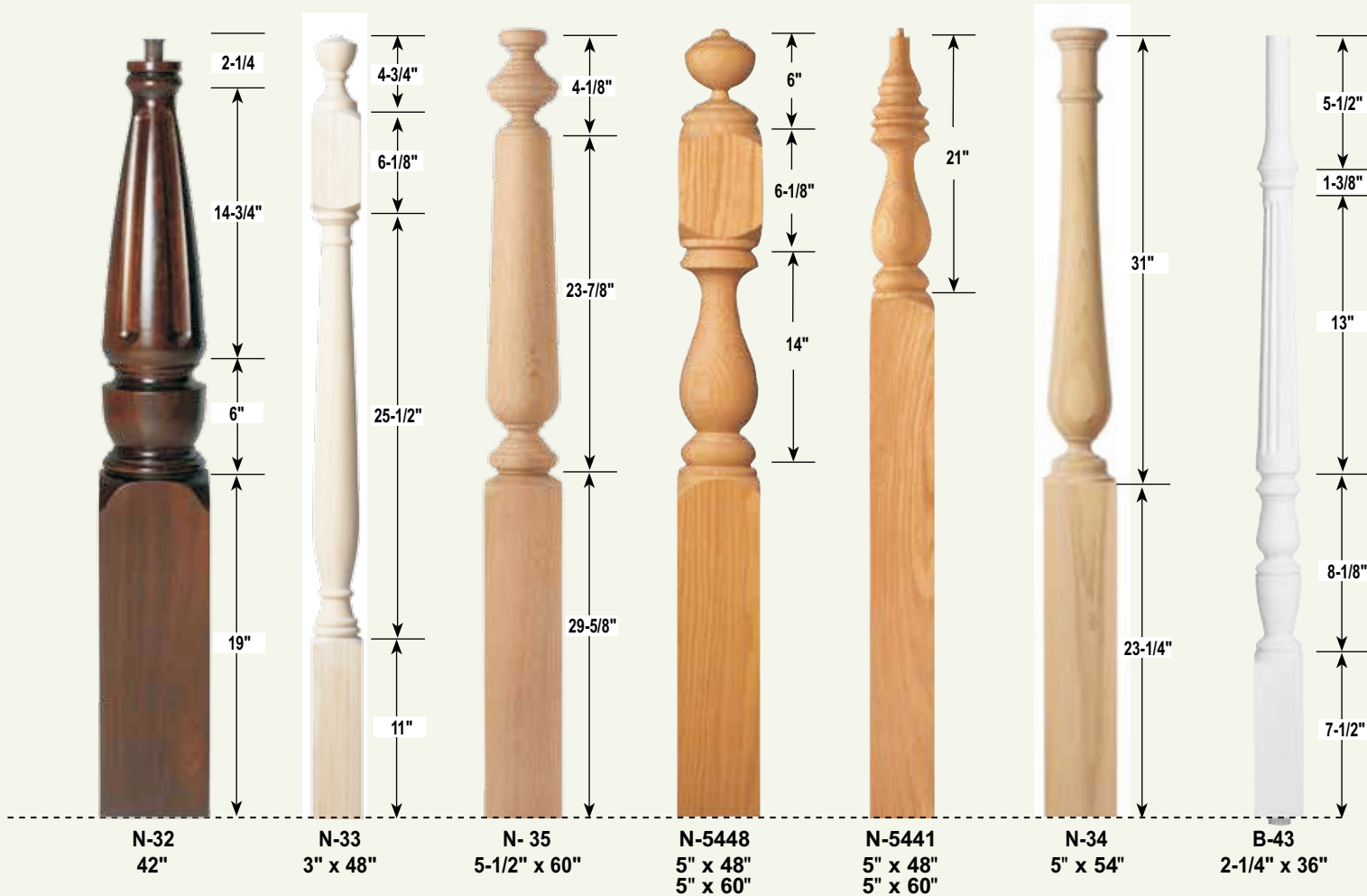
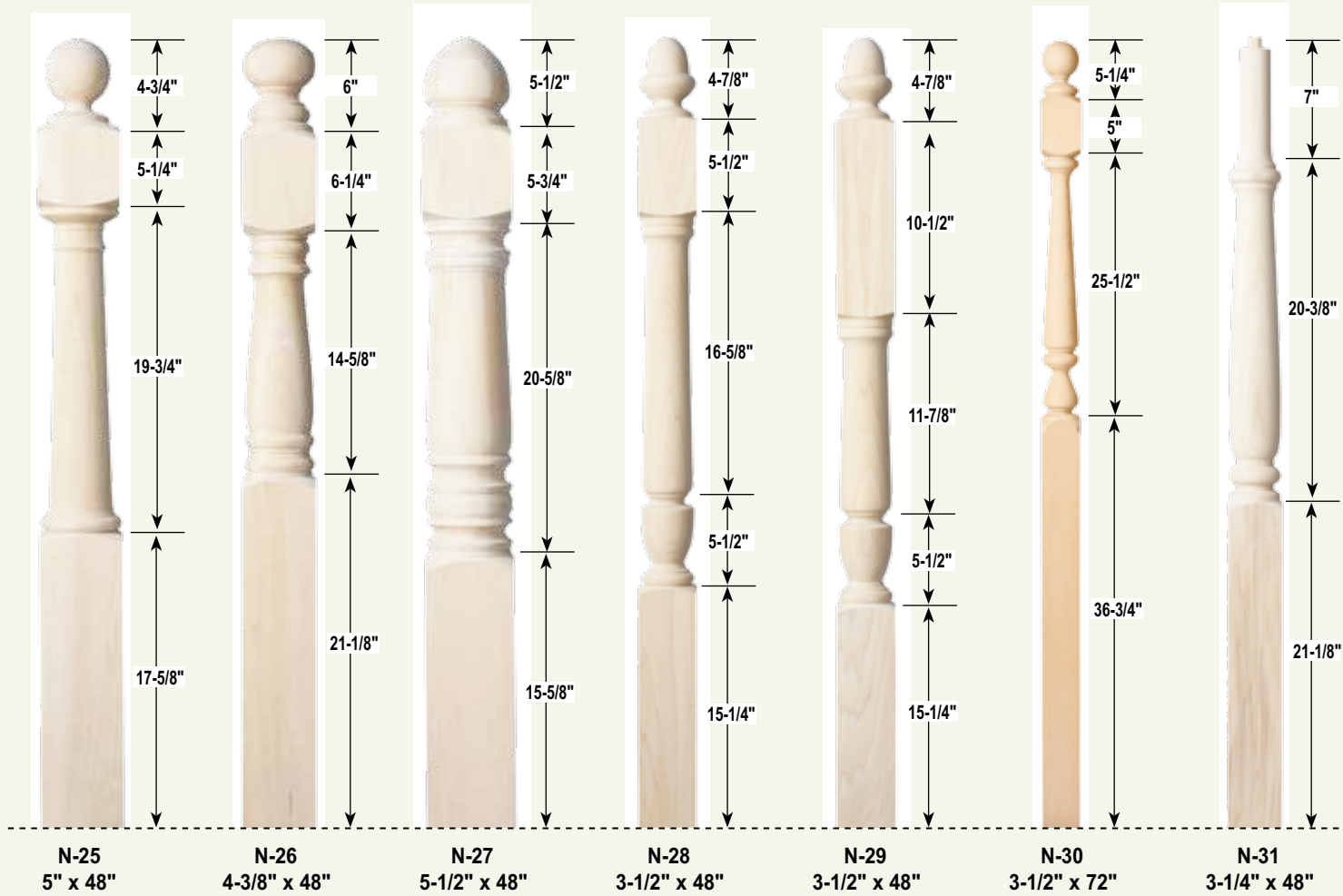

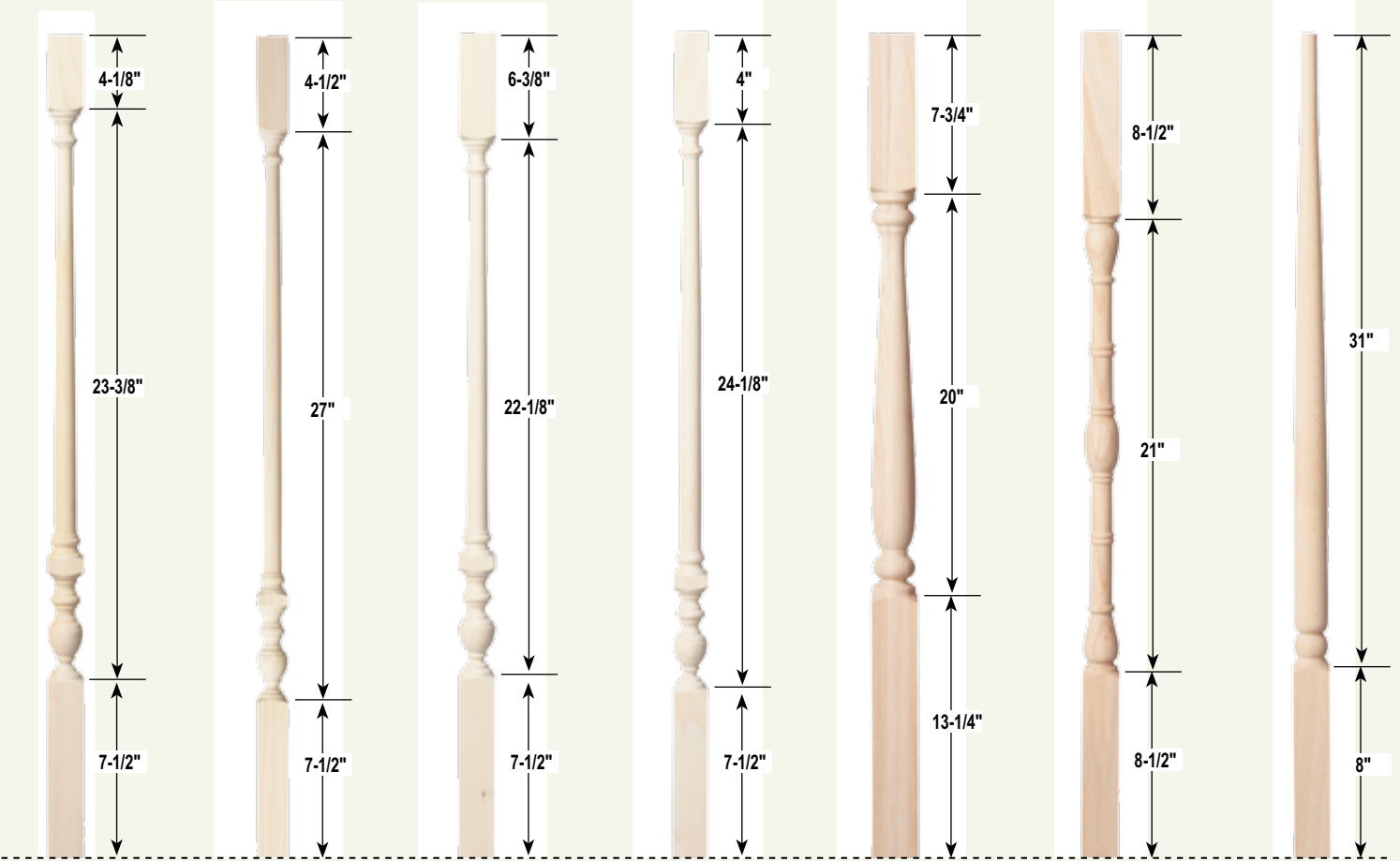

B-35 1-1/2" x 35"
B-37 1-1/2" x 39"
B-34 1-1/2" x 36"
B-36 1-1/2" x 36"
B-20 2-1/4" x 41"
B-22 1-3/4" x 38"
B-21 1-3/4" x 39"

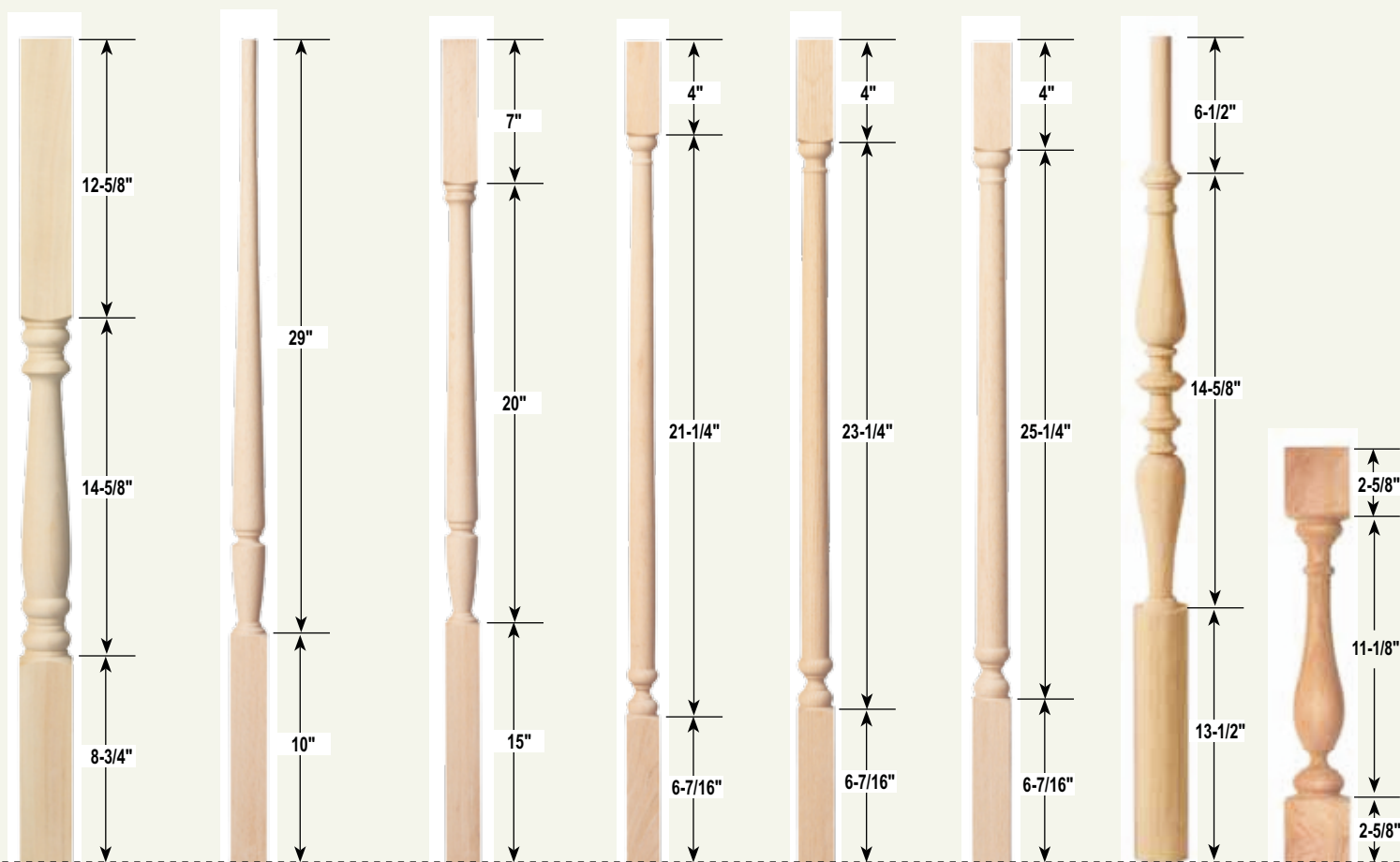

B-33 2-1/4" x 36"
B-41 1-3/4" x 39"
B-40 1-3/4" x 41"
B-25 1-1/2" x 32"
B-27 1-1/2" x 34-1/4"
B-26 1-1/2" x 36"
B-8 2-3/4" x 42"
B-CIE-CV 2-5/8" x 16-1/4"

Finish Options

The process of powder coating involves applying dry pigments using an electrostatic process, then baking them on to create a lasting and durable, as well as beautiful, finish.

The products found in the following section implement the powder coating technique. When ordering, please use the Finish Options Guide below.

Please indicate the type of finish by using the following abbreviations:

- AN** = Antique Nickel
- B** = Flat Black Powder Coat
- SP** = Grey Speckled Powder Coat
- SAT** = Satin Black
- CV** = Copper Vein Powder Coat
- ORC** = Oil Rubbed Copper
- ORB** = Oil Rubbed Bronze

Example: CS 16.5.5-B = Carolina Stair Flat Black Twist & Basket Newel



Iron Balusters

Regular Twist

Iron Chain
Color Samples
Available
Upon Request

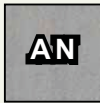

Antique Nickel
Powder Coat



Satin Black
Powder Coat



Flat Black
Powder Coat



Copper Vein
Powder Coat



Grey Speckled
Powder Coat

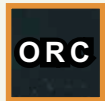

Oil Rubbed
Copper



Oil Rubbed
Bronze

Finish Options

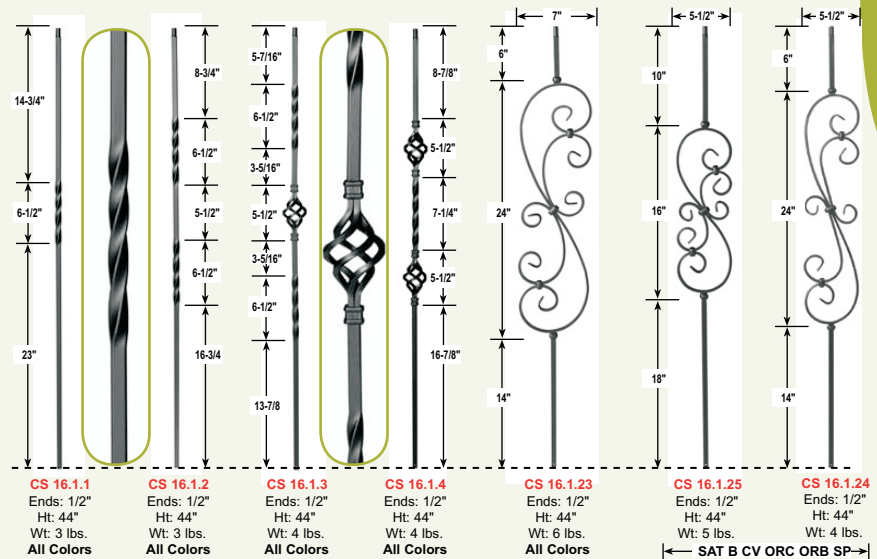

Iron Balusters

Tapered & Hammered

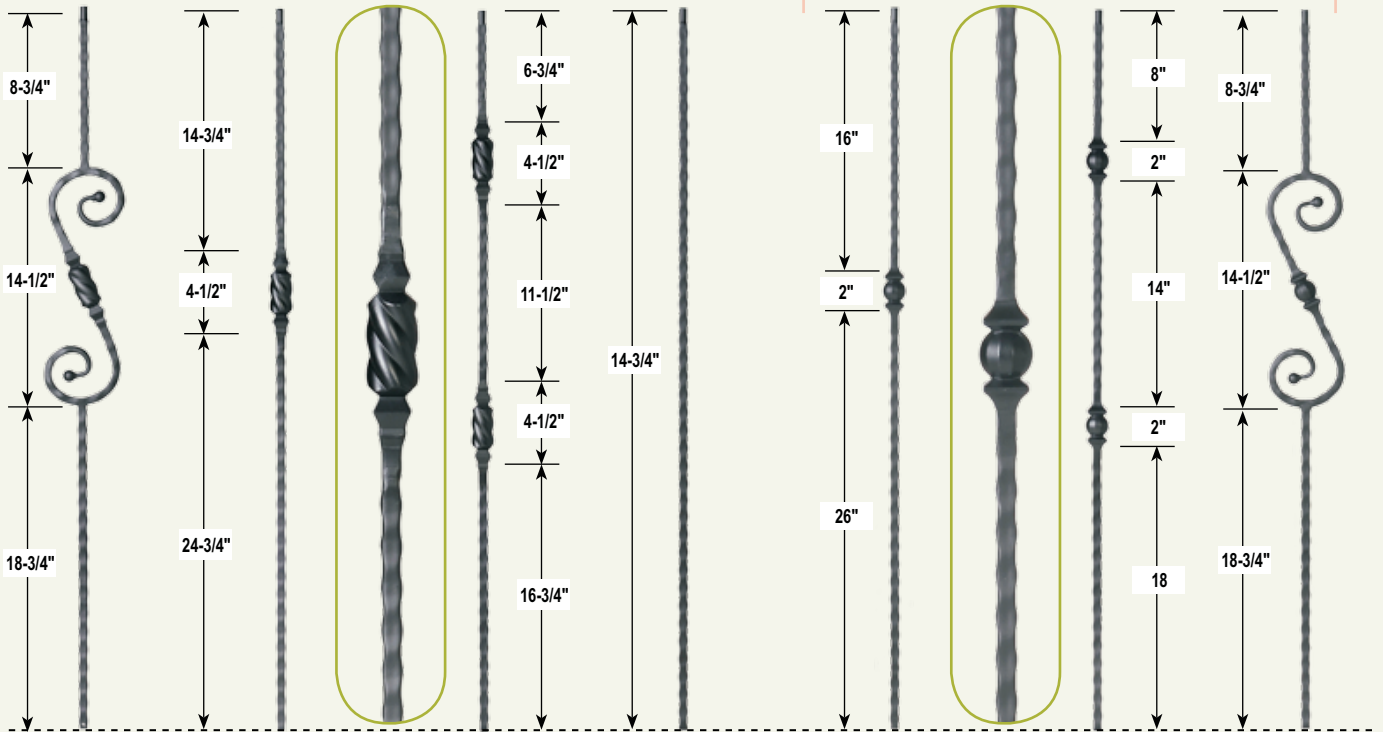

Model	Ends	Height	Weight
CS 2.9.11	Ends: 9/16"	Ht: 44"	Wt: 4 lbs.
SAT B CV ORB			
CS 2.9.12	Ends: 9/16"	Ht: 44"	Wt: 3.6 lbs.
SAT B CV ORB			
CS 2.9.13	Ends: 9/16"	Ht: 44"	Wt: 5 lbs.
SAT B CV ORB			
CS 2.9.20	Ends: 9/16"	Ht: 44"	Wt: 3 lbs.
SAT CV ORB AN			
CS 2.9.28	Ends: 9/16"	Ht: 44"	Wt: 4 lbs.
SAT CV ORB AN			
CS 2.9.26	Ends: 9/16"	Ht: 44"	Wt: 3.5 lbs.
SAT CV ORB AN			
CS 2.9.27	Ends: 9/16"	Ht: 44"	Wt: 4 lbs.
SAT CV ORB			

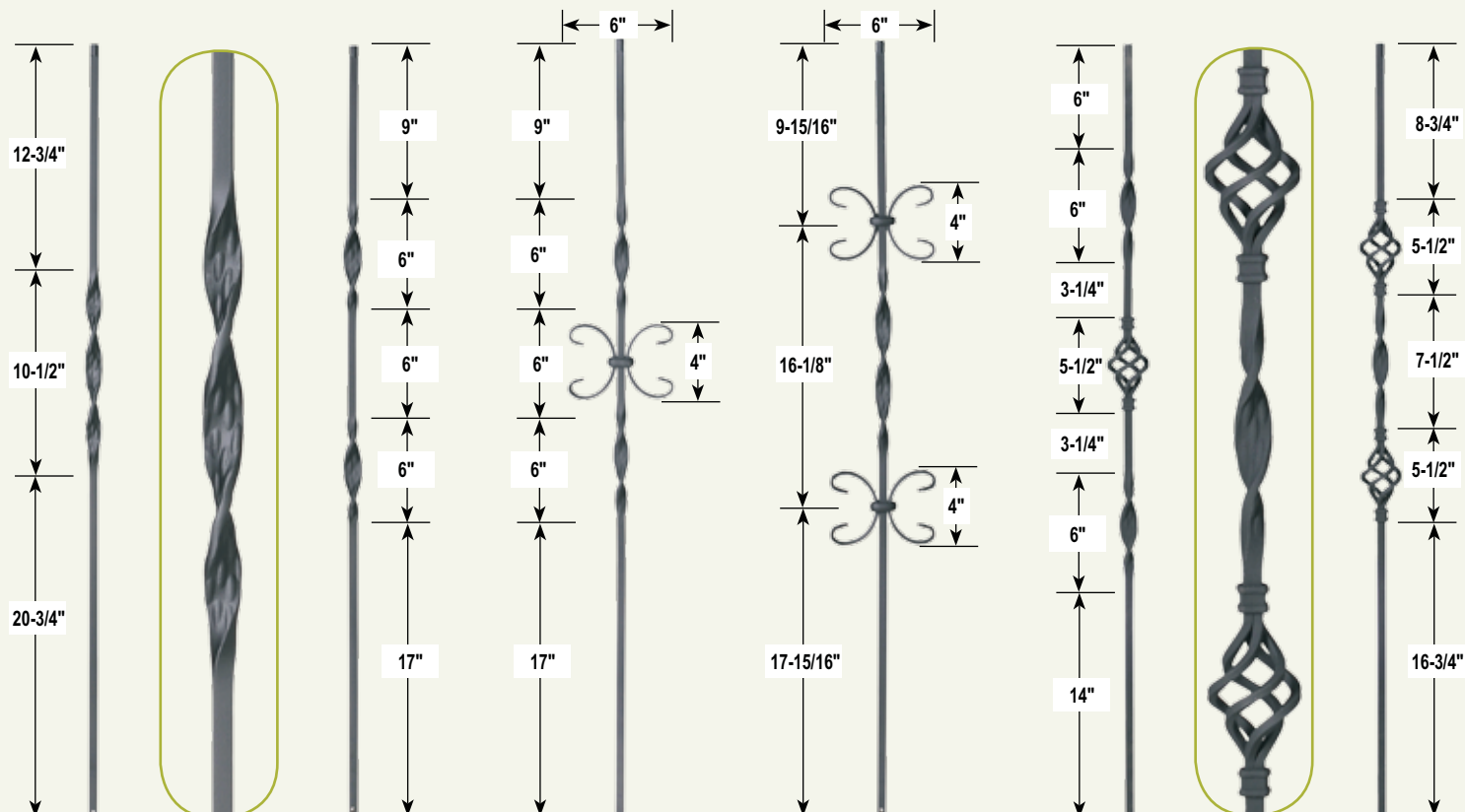

CS 16.1.5 Ends: 1/2" Ht: 44" Wt: 3.2 lbs.
CS 16.1.6 Ends: 1/2" Ht: 44" Wt: 3.2 lbs.
CS 16.1.10 Ends: 1/2" Ht: 44" Wt: 4 lbs.
CS 16.1.11 Ends: 1/2" Ht: 44" Wt: 4 lbs.
CS 16.3.6 Ends: 1/2" Ht: 44" Wt: 4 lbs.
CS 16.3.7 Ends: 1/2" Ht: 44" Wt: 4 lbs.

SAT B CV ORC ORB

All item numbers in red available in Hollow Tube

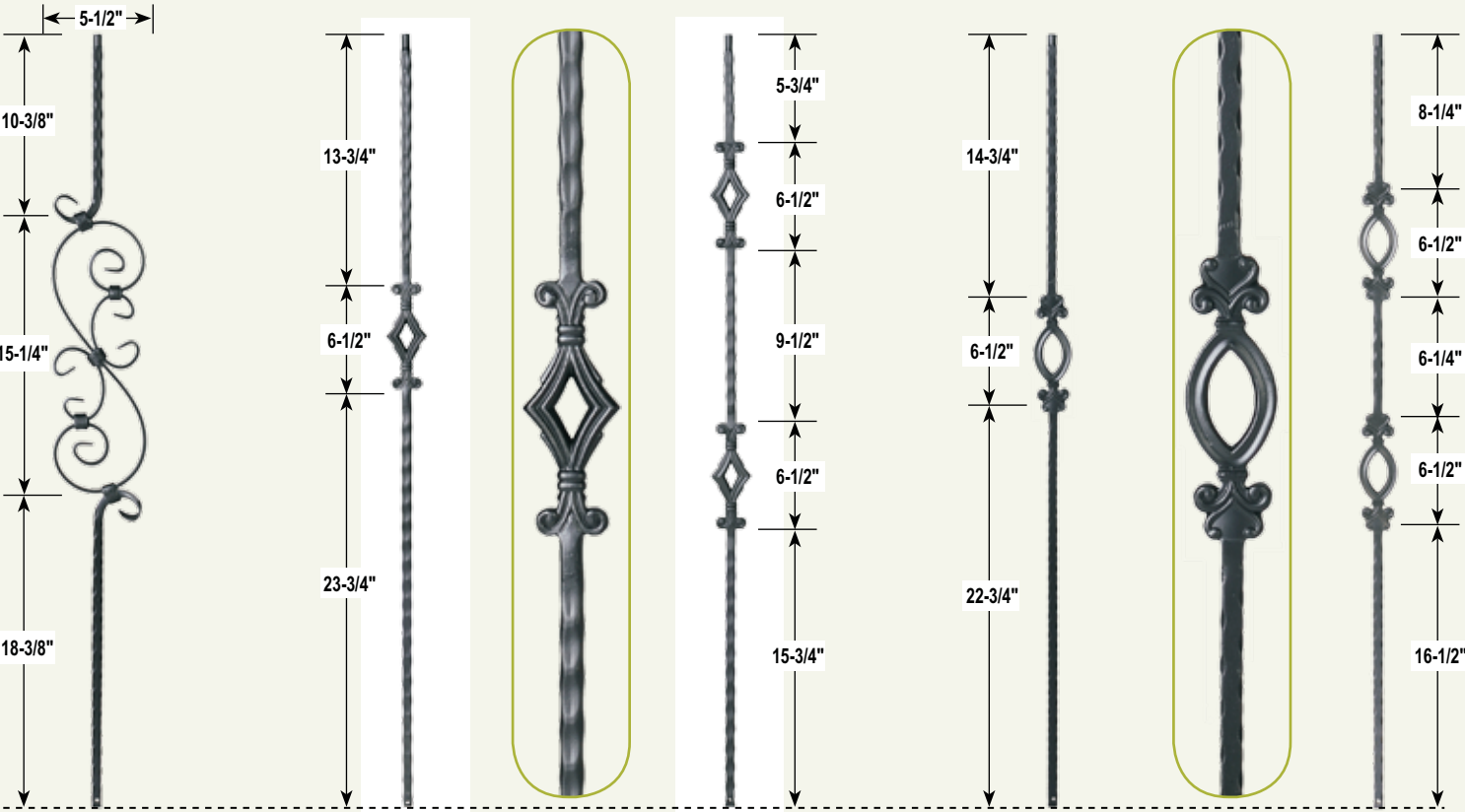

CS 2.9.7 Ends: 9/16" Ht: 44" Wt: 4 lbs. SAT ORB
CS 2.9.3 Ends: 9/16" Ht: 44" Wt: 3.5 lbs. SAT B CV ORB
CS 2.9.4 Ends: 9/16" Ht: 44" Wt: 3.8 lbs. SAT B CV ORB
CS 2.9.5 Ends: 9/16" Ht: 44" Wt: 3.5 lbs. SAT B CV ORC ORB SP
CS 2.9.6 Ends: 9/16" Ht: 44" Wt: 3.8 lbs. SAT B CV ORC ORB SP

Iron Balusters

Wave & Curl Forged

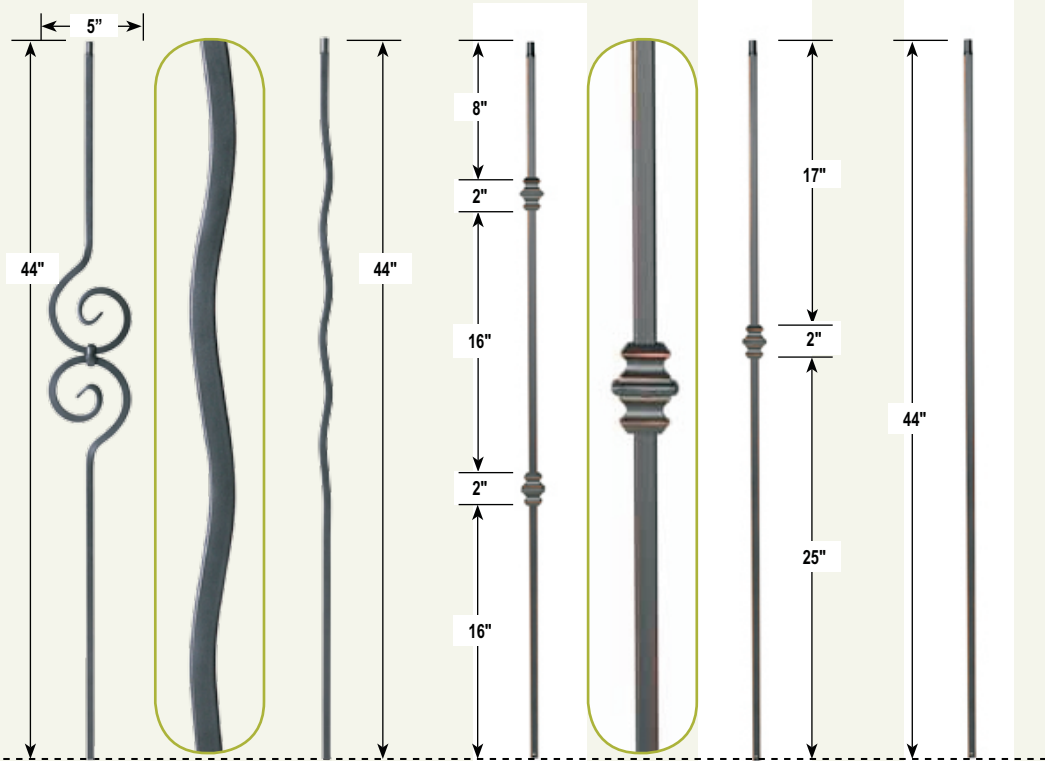

<p>CS 2.10.1 Ends: 1/2" Ht: 44" Wt: 3.5 lbs.</p>	<p>CS 2.2.3 Ends: 1/2" Ht: 44" Wt: 3 lbs.</p>	<p>CS 16.1.35 Ends: 1/2" Ht: 44" Wt: 3 lbs. All Colors</p>	<p>CS 16.1.34 Ends: 1/2" Ht: 44" Wt: 3 lbs. All Colors</p>	<p>CS 16.2.1 Ends: 1/2" Ht: 44" Wt: 3 lbs. All Colors</p>
<p>← SAT B CV ORC ORB SP →</p>				



Fusion

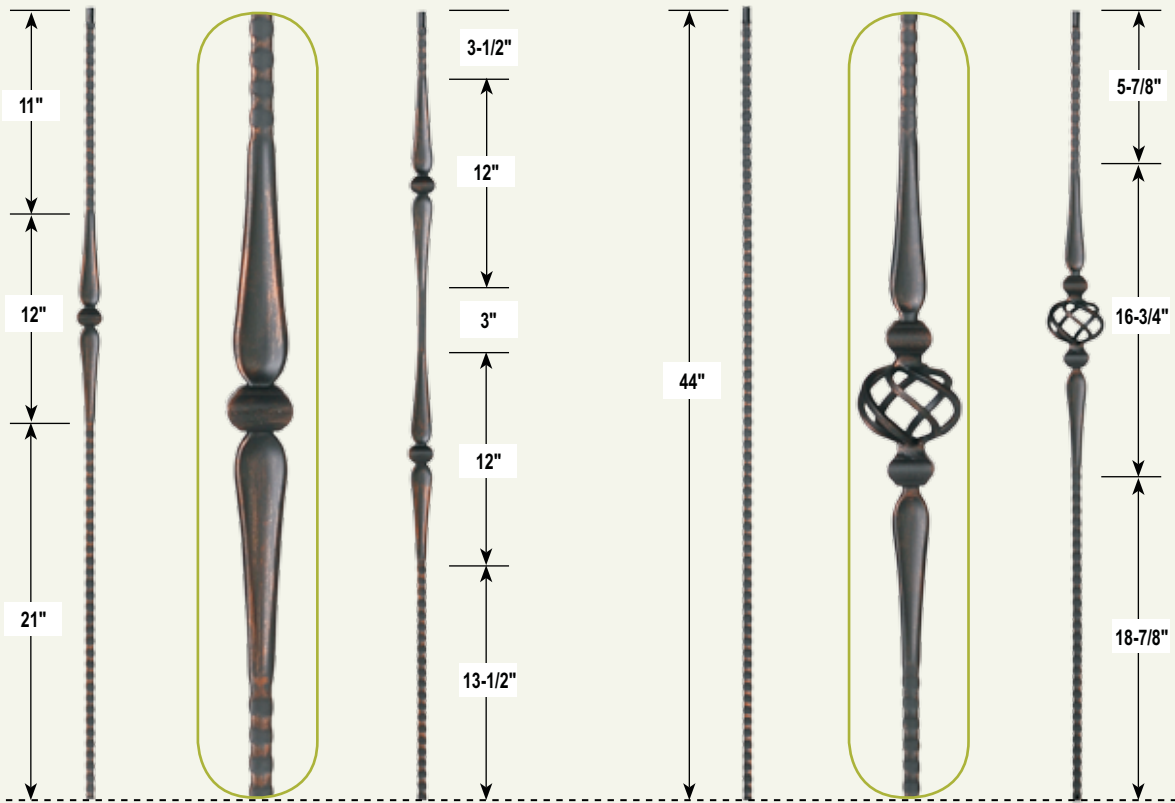

CS 16.5.2
Ends: 9/16" Square
Ht: 44"
Wt: 3.4 lbs.
All Colors

CS 16.1.8
Ends: 9/16" Square
Ht: 44"
Wt: 3.8 lbs.
All Colors

CS 16.1.7
Ends: 9/16" Square
Ht: 44"
Wt: 2.9 lbs.

CS 16.1.9
Ends: 9/16" Square
Ht: 44"
Wt: 4 lbs.

SAT B CV ORC ORB SP

All Item numbers in red available in Hollow Tube

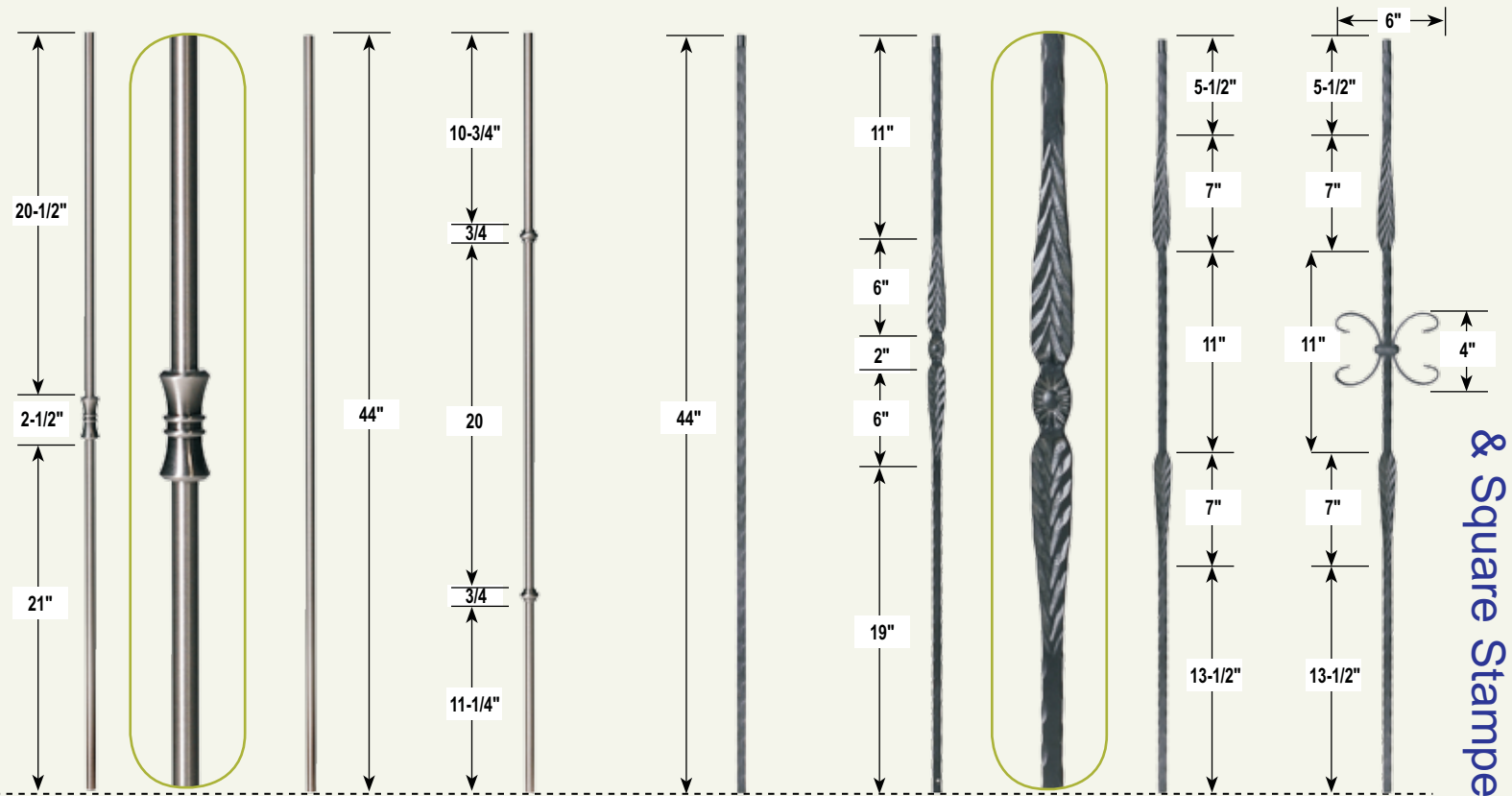

CS HG
Ends: 5/8" Round
Ht: 44"
Wt: 3 lbs.

CS PLA
Ends: 5/8" Round
Ht: 44"
Wt: 3 lbs.

CS KNUC
Ends: 5/8" Round
Ht: 44"
Wt: 3 lbs.

CS 16.3.8
Ends: 9/16"
Ht: 44"
Wt: 2.8 lbs.

CS 16.3.9
Ends: 9/16" Square
Ht: 44"
Wt: 3.5 lbs.

CS 16.3.10
Ends: 9/16" Square
Ht: 44"
Wt: 3.5 lbs.

CS 16.3.11
Ends: 9/16" Square
Ht: 44"
Wt: 3.5 lbs.

Dull Chrome Only

SAT B CV ORC ORB



Zip Clip Installation

Zip Clip



Flat Shoe Z-CS16.3.1
1/2" Opening
SAT, ORC, ORB

Zip Clip



1 Pitch Shoe Z-CS16.3.2
1/2" Opening
SAT, ORC, ORB

Zip Clip



2 Pitch Shoe Z-CS16.3.4
1/2" Opening
SAT, ORC, ORB

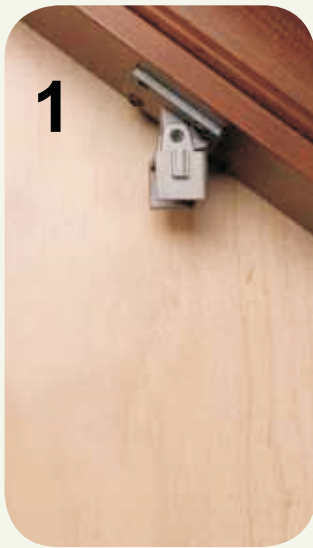

1
Install Clip To Handrail and Tread

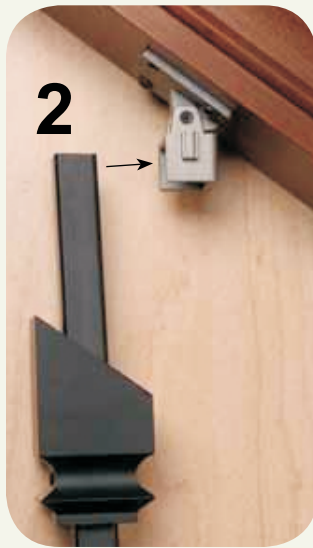

2
Slide Iron Baluster In Place With Shoes Installed

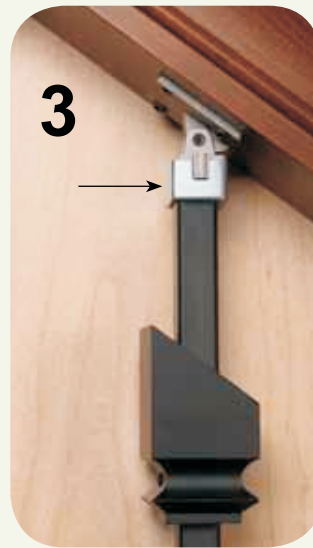

3
Snap Retaining Clip In Place



4
Slide Shoe In Place And Tighten



Pitch Shoe With Set Screw CS 16.3.2
1/2" Opening

CS 16.3.17
9/16" Opening
All Colors



Adjustable Knuckle With Set Screw CS 16.5.1
1/2" Opening
All Colors



Base Shoe CS 16.3.1
1/2" Opening

CS 16.3.3
9/16" Opening
All Colors
Available with set screw



Epoxy Kit



Olé Iron Slides

With the advent of the adjustable iron slide baluster, the do it yourself person can now design and install their own balustrade. Using only a drill, screwdriver and an allen wrench, the adjustable iron baluster can replace your old wood spindles without the expense of a professional. Leave your wood rail and newels in place, remove the wood spindles and replace them with a wrought iron balustrade quickly and without a big mess. Presto, you have a new design favor for your living area.

Scan this code to watch the video

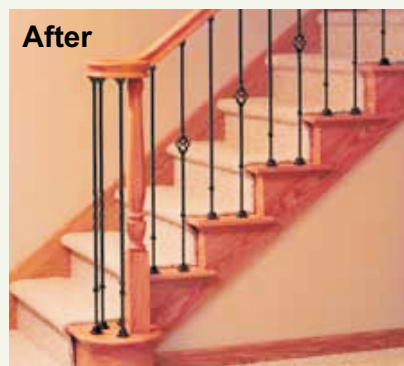
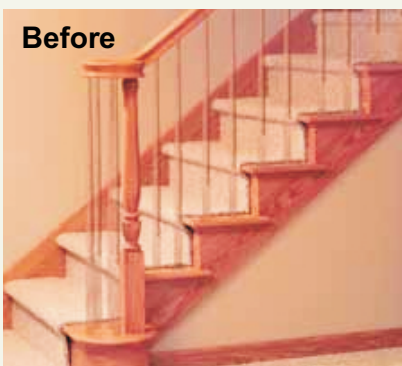

Ole Iron Slides™ is a trademarked and patented adjustable baluster owned by Carolina Stair Supply Inc.

